

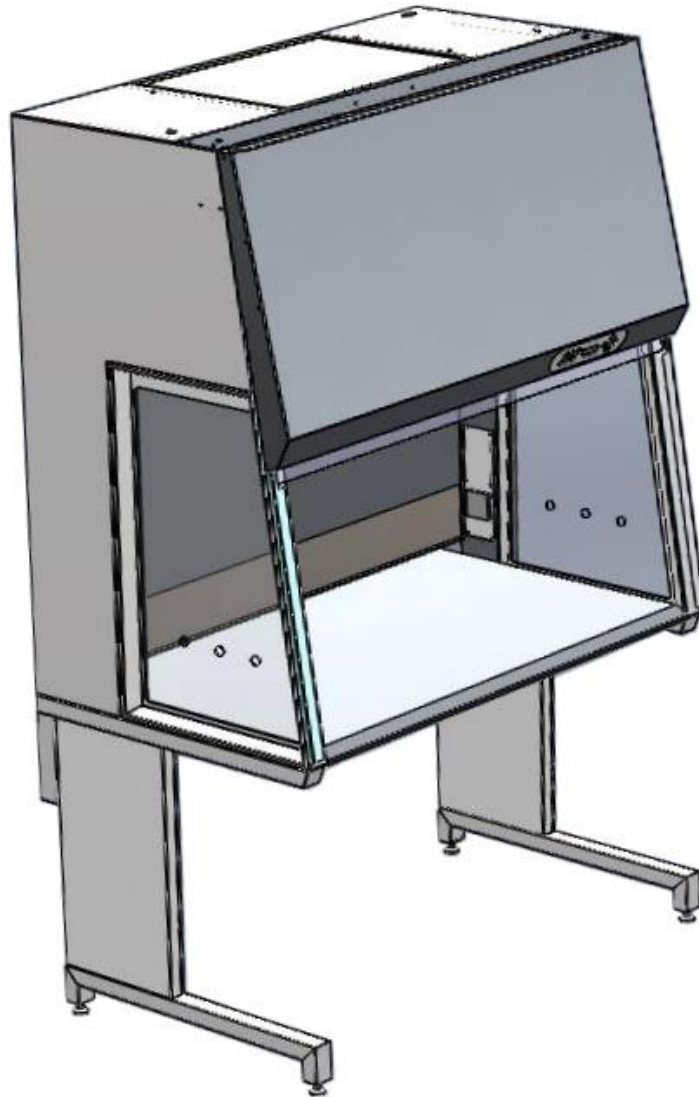



# INSTRUCTION MANUAL



## Fortuna

900, 1200, 1500 & 1800  
Clean Bench

**Symbols used in this manual**

	<b>Note</b>
	Used to direct attention to a special item.
	<b>Warning</b>
	Used in case of danger of a serious accident or lethal injury.
	<b>Caution</b>
	Used in case of danger of medium or minor injuries or physical damage.

This document is the original instruction manual in accordance with the current Machinery Directive. This document is the reference for any translation of this instruction manual. In case of doubts or uncertainties the text in the original instruction manual is the valid.



LaboGene A/S  
Bjarkesvej 5  
DK-3450 Allerød

Phone No. +45 39 40 25 66  
Fax No. +45 39 95 25 66

Mail [info@labogene.com](mailto:info@labogene.com)  
Internet [www.labogene.com](http://www.labogene.com)

## Table of contents

<b>1</b>	<b>Introduction to this instruction manual</b>	<b>5</b>
<b>2</b>	<b>Introduction</b>	<b>5</b>
2.1	Operating conditions and factory settings	5
2.2	Compliance and basic features	5
2.3	Standard Fortuna cabinet	6
2.4	Safety precautions	6
<b>3</b>	<b>Description</b>	<b>6</b>
3.1	Safety systems	6
3.2	HEPA filter	7
3.3	Control Panel: Standard set up	8
3.3.1	Control panel	8
3.3.2	Display	9
3.4	Window positions	9
3.5	Lighting in working chamber	10
3.6	UV light	10
3.7	Working area	10
<b>4</b>	<b>Installation of the Fortuna cabinets</b>	<b>10</b>
4.1	General considerations	10
4.2	Specific considerations	11
4.3	Transport	11
4.4	Sterile cabinets and open flames	12
4.5	Moving the Fortuna cabinets	12
4.6	Connecting utilities to the Fortuna cabinets	12
<b>5</b>	<b>Start-up of the Fortuna cabinets</b>	<b>13</b>
5.1	Preparation	13
5.2	Connections	13
5.3	Assemble the stand for the Fortuna cabinets	14
5.4	Levelling of the Fortuna cabinets	14
5.5	Power connection of the Fortuna cabinets	14
5.6	Installation test on the Fortuna cabinets	15
<b>6</b>	<b>Operating the Fortuna cabinets</b>	<b>16</b>
6.1	Overview of the user menu	18
6.2	Programming	19
6.3	Supervision – Alarm	19
6.4	PIR sensor	19
6.5	Setting of light	20
6.6	Start-up of the Mars and Mars Pro cabinets	20
6.7	Operating modes of the Fortuna cabinets	20
6.7.1	Off mode	20
6.7.2	Working mode (Operating mode)	21
6.7.3	Standby mode	21
6.7.4	UV mode	21
6.8	Loading the working chamber	21
6.9	Working safely - Recommendations	22
6.9.1	Before start-up	22
6.10	While working	22
6.10.1	After work	23
6.11	Interrupting an ongoing procedure	23
6.12	Shut down of the Fortuna cabinets	23
6.13	Disposal of cabinets	24

## Table of contents

<b>7</b>	<b>Cleaning/Decontamination of cabinets .....</b>	<b>24</b>
7.1	Caring for and cleaning of stainless steel .....	24
7.2	Caring for and cleaning of coated surfaces .....	25
7.3	Disinfection of working chamber .....	25
7.4	Rinsing of working chamber .....	25
7.5	UV Disinfection after cleaning the working chamber .....	25
7.6	Microbiological decontamination .....	25
7.7	Cleaning of external surfaces .....	26
7.8	Cleaning the windows .....	26
<b>8</b>	<b>Service and maintenance of Fortuna cabinets .....</b>	<b>26</b>
8.1	Service on Fortuna cabinets .....	27
8.2	Working chamber lights, replacement .....	27
8.3	Optional UV lights .....	28
8.4	Replacement of fuses .....	28
8.5	Replacement of laminator .....	29
8.6	Replacements and repairs .....	29
8.7	Disposal of cabinet .....	29
<b>9</b>	<b>Specifications .....</b>	<b>30</b>
9.1	Spare parts .....	34
<b>10</b>	<b>Quality testing of the Fortuna cabinets .....</b>	<b>35</b>
10.1	Test terms and definitions .....	35
10.2	What is required by EN 12469 to be tested .....	35
10.3	The factory quality test of the Fortuna cabinets .....	35
10.4	The factory check list and factory test report .....	35
10.5	Test equipment needed to perform installation tests and service tests ..	35
10.6	Test information .....	36
<b>11</b>	<b>Options for Fortuna cabinets .....</b>	<b>36</b>
11.1	LED light .....	36
11.2	PIR sensor .....	37
11.3	Utility valves .....	37
<b>12</b>	<b>Annex 1 - Factory check list and factory test report .....</b>	<b>38</b>
<b>13</b>	<b>Annex 2 - Service log book .....</b>	<b>47</b>
<b>14</b>	<b>Annex 3 - Decontamination statement .....</b>	<b>48</b>
<b>15</b>	<b>Annex 4 - Declaration of conformity – Fortuna .....</b>	<b>49</b>

## Instruction manual for Fortuna

### 1 Introduction to this instruction manual

This instruction manual gives a detailed description of the standard Fortuna cabinets: Functional description and principle, installation, start-up, operation, cleaning and decontamination, maintenance, specifications, testing and service log book.

### 2 Introduction

The Fortuna is a series of vertical sterile laminar airflow cabinets which incorporate the latest laminator technology and energy-saving designs with HEPA-filtration and a range of options that gives optimal protection of your product, samples or equipment.

The Fortuna range of cabinets, the ideal choice for your laboratory, wherever a sterile working area is required. PCR, cell culture, microbiology applications, microprocessor manufacturing, plant tissue culture, micro-electronics assembly, optics servicing, are just some examples of installations of the Fortuna range.

#### 2.1 Operating conditions and factory settings

The EN 12469 standard requires that the downflow air velocity is in the interval 0,25 m/s – 0,50 m/s.











The LaboGene default downflow setting is 0,32 m/s for 350 mm work opening with a maximum variation of  $\pm 20\%$  on single measuring points, which is in accordance with annex G in EN 12469.

	<p><b>Warning</b></p> <p>The Fortuna cabinet should only be used with the work opening that is it set up for. Running a Fortuna cabinet with a higher opening than the setup stipulates is NOT recommended.</p>
--	---



#### 2.2 Compliance and basic features

The cabinets comply with the requirements stipulated in EN 12469.

The Fortuna cabinets have:

-  Microprocessor controller with:
  -  LCD display indicating fan and alarm status.
  -  Flow (Air velocity) sensors.
  -  Clock (7 days) and hour-counter.
  -  Pre-setting of automatic start-up, timer for delay start and timer for UV-light.
  -  Alarm for any deviation from safety conditions.
  -  Full programming of alarms and fans through pass word protection.
-  Ergonomically correct sloping front for maximum operator comfort.
-  Motor-driven sliding front window.
-  Side windows, for perfect light conditions and view to the surroundings.
-  Three air velocity modes: Fan off or reduced air velocity or normal air velocity.



## Instruction manual for Fortuna

-  One-piece table top for big working area.
-  Digital electrical direct adjustable Fan speeds.

### 2.3 Standard Fortuna cabinet



A standard Fortuna cabinet comprises:

The basic unit - four sizes 900, 1200, 1500 and 1800 including:

-  2 electrical outlets.
-  Side windows (left and right) with three holes.

For each cabinet, a support stand must be ordered.

### 2.4 Safety precautions

-  To avoid unintended or improper operation of the cabinet, please carefully read this manual.
-  If you have questions related to the function or control of the cabinet or wish to order spare parts, please always indicate the nameplate data.

	<b>Caution</b>
	The proper function and safety of the cabinet is only secured if personnel authorized by us perform the required tests, maintenance and repair work.

Please also refer to sections “Testing” and “Maintenance”.

The following precautions must be taken for operation of the Fortuna-series.

	<b>Caution</b>
	Never operate the Fortuna cabinets if the fan compartment cover is removed.

If this cover is removed, the cabinet will give no protection of the operator or of the environment and the fan will run with openly rotating blades.

	<b>Caution</b>
	Always keep hands and arms away from the work chamber when activating the sliding window.

	<b>Caution</b>
	The airspeed monitoring system needs approximately 5 minutes to warm up and stabilise after the fan has been switched on.

## 3 Description

### 3.1 Safety systems

The Fortuna cabinets have the following build-in safety systems:

**Product protection**

The steady airflow within the air system ensures constant downflow, allowing the HEPA filter to remove contaminants so that the product handled in the work chamber is always surrounded by near particle free air.

The laminarity of the downflow air ensures that harmful particles are not carried over the work chamber thus preventing cross-contamination.

**HEPA Filter**

On the Fortuna cabinets, the downflow air within the work chamber is cleaned by a HEPA H14 filter.

**UV Safety**

To protect from UV radiation, the optional UV light will not turn on if the front window is open. While the UV light is on, the front window must remain closed. The closed window blocks out the UV rays.

Opening the window will cause the UV light to turn off. If the light is turned on in the cabinet, the UV light will turn off automatically.

**Airflow monitoring**

Monitoring of downflow air velocity guarantees that product protection remains uncompromised.

Airflow monitoring, using build-in flow sensor, determine the velocity of the airflow in the work chamber.

As soon as airflow velocity rise above or fall below a specified alarm value, an audible and a visual alarm is activated.

**3.2 HEPA filter**

The filter system consists of a HEPA H14 filters for downflow air.

Air is drawn from the surrounding room in through the prefilter on top of the cabinet, through the HEPA H14 downflow filter and laminator into work chamber.

The room air is mixed with recirculating HEPA filtered air from the downflow in the work chamber, and filtered proportionally by the downflow and exhaust filters. The filtered air is then supplied as near particle free air into the work chamber of the cabinet, and exhausted as near particle free air into the surrounding environment, or into an external exhaust system.

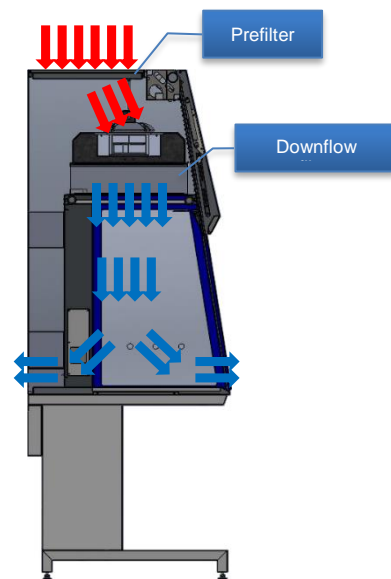

Product name	Catalogue No.
Fortuna 900 downflow filter	9.000.050.001
Fortuna 1200 downflow filter	9.000.050.002
Fortuna 1500 downflow filter	9.000.050.003
Fortuna 1800 downflow filter	9.000.050.004

## Instruction manual for Fortuna

### 3.3 Control Panel: Standard set up

All functions are controlled by an electronic card with microprocessor via the control panel with display shown below.

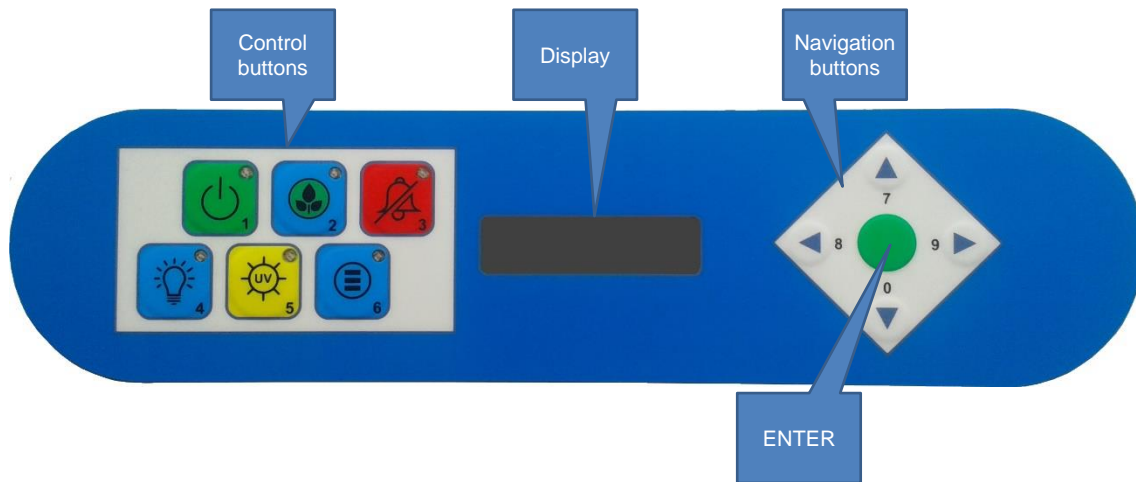

#### 3.3.1 Control panel

1. Button 1 with green LED light to select the fan ON/OFF at normal velocity. The green light indicates that the fan is running at normal velocity, and that conditions are safe. During start-up the low flow alarm will be active and the LED only switched on when the conditions are safe for working in the cabinet.
2. Button 2 with blue LED to select the fan ON/OFF at reduced velocity. Can be adjusted to any level desired for individual requirements (See Service menu). When switching to reduced velocity the low flow alarm is activated and the light in the cabinet is turned off to indicate not safe conditions.
3. Button 3 with red LED. Alarm indicator with blinking red light and acoustic alarm. Press the button to silence the acoustic alarm.
4. Button 4 with blue LED for normal light ON/OFF.
5. Button 5 with yellow LED to select ON/OFF of UV light (optional). The timer for the light is set in the user menu (See User menu).
6. Button 6 with blue LED can be connected to an internal plug in the chamber for remote on/off of the plug/gas resettable valve.
7. Button 7: Window open (upwards movement).
8. Not active: Only for programming/navigation.
9. Not active: Only for programming/navigation.
10. Button 0: Window close (downwards movement).
11. Blue button "ENTER".



## Instruction manual for Fortuna

### 3.3.2 Display

The display is used for showing the current running conditions or the current alarm condition. The display is further used during setup of the cabinet in either user mode or service mode (password protected).

Some examples:

In the top right-hand corner of the display, the navigation possibilities are shown. These are typically left arrow (button 8), ENTER and right arrow (button 9).



On start-up after power disconnect or after power failure the above alarm will be active. Press the blue ENTER button to clear the alarm.

The main screen showing the time and date.



The display shows the current air velocity on flow 1, which is the downflow air velocity by default. Value in m/s.

### 3.4 Window positions

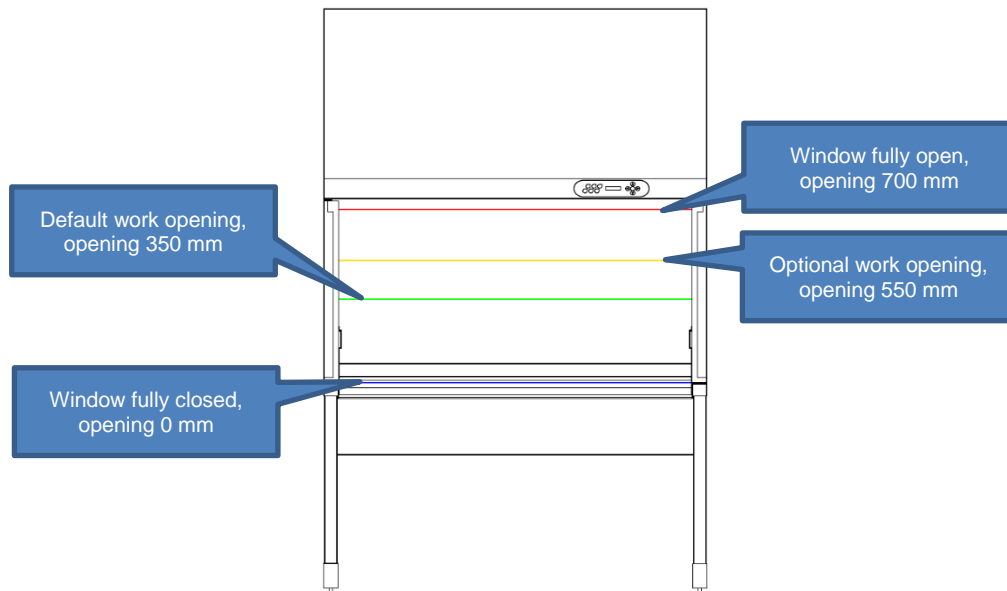

For easy loading and unloading of the cabinet, the window can be raised to create a 700 mm opening on front of the cabinet.

On the Fortuna cabinets the work opening is 350 mm (default) or optionally 550 mm.

## Instruction manual for Fortuna

### 3.5 Lighting in working chamber

All Fortuna has built in light in the working chamber. All cabinets are fitted with two florescent light tubes mounted at the top of the working chamber to avoid disturbances of the airflow. This position above the laminator gives a good and uniform light on the entire working area. The control system allows the user to adjust the intensity from 0 to more than 750 Lux. The reachable light level is about 2000 Lux in the standard cabinets, measured on the table tops. LED light can optionally be delivered. Please refer to Options paragraph.

Product name	Catalogue No.
Light tube 900	9.000.040.011
Light tube 1200	9.000.040.012
Light tube 1500	9.000.040.013
Light tube 1800	9.000.040.014

### 3.6 UV light

The optional, factory-installed UV light is at the top of the front section of the working chamber. The standard LaboGene control system is prepared for full control of safety and timing for the use of UV light – see section “UV light option” for operation and build in safety measures.

Remember that UV light does not penetrate areas blocked from the direct light and that it does not represent a substitute for good old fashion mechanical cleaning of the inner surfaces of the safety cabinet.

### 3.7 Working area

All Fortuna cabinets are, as default, delivered with one solid fixed table top. They are designed for easy cleaning, minimum vibrations and maximum working area. As standard it is made of 2 mm stainless steel plate (AISI 304) wrapped around a chipboard for rigidity.

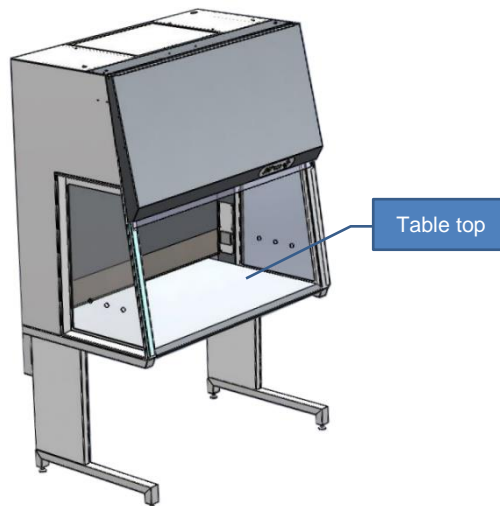

## 4 Installation of the Fortuna cabinets

### 4.1 General considerations















A sterile cabinet is a ventilated cabinet, which provides product protection. It has an open front and back with outward airflow and downward HEPA filtered laminar airflow over the entire working area for product protection.

The cabinets are neutral with respect to pressure in the room, as all air drawn into the cabinet is exhausted back into the room.

## Instruction manual for Fortuna

### 4.2 Specific considerations

To ensure that the built-in safety features of the cabinets function properly, the location of installation must be selected carefully. The recommended ambient conditions, for safe and proper operation, are listed below.

-  All cabinets are developed and produced for use in clean environments.
-  Cabinets must not be operated outdoors or in environments with extreme air pollution. The safety cabinets are not intended to filter vapours containing acids or organic solvents. The safety cabinets must not be used as a fume hood.
-  Up to 2000 m above sea level.
-  The wall socket to which the cabinet is connected must be fused by a minimum 10 A fuse.
-  The wall socket should be placed so accidental switch off is unlikely. A wall socket without a switch is recommended.
-  The power cord is the mains disconnect.
-  The location must be capable of supporting the weight of the device.
-  If the factory-approved stand is not purchased, the holding device must be rated for twice the cabinet weight.
-  Adequate room height. For cabinets, which are not connected to an exhaust system, the distance between the exhaust air opening on the cabinet and the room ceiling must be at least 400 mm.
-  There must be at least 100 mm clearance on the rear and non-utility side of the cabinet.
-  For sides with external utility connections leave 150 mm clearance.
-  The location must be equipped with an appropriate ventilation system.
-  Room temperature between 10 °C and 35 °C.
-  Relative humidity must not exceed 80%, up to 31 °C and is decreasing linearly to 50% at 40 °C.
-  The cabinets are for indoor use only.

Room ventilation should preferably be a ventilation system that complies with the national requirements for the application.

The inlet air and exhaust air openings of the room ventilation must be located so that drafts do not impair the function of the sterile cabinet air system.

### 4.3 Transport

The cabinet can be moved through a standard 800 mm wide door.

Transport of the Fortuna cabinets can be carried out by lifting the cabinet using a forklift either sideways under the support stand or directly under the trough. Furthermore, the cabinet can be moved manually by using hooks in the dedicated holes in the support stand.

	<b>Caution</b>
	Whenever transportation of the cabinet is needed, precautions should be taken to prevent it from overturning due to the high-located mass centre.

	<b>Caution</b>
	To prevent damage to the cabinet it must be handled as fragile goods.

Storage of the cabinet must be in an environment of maximum 80 % relative humidity and at temperatures between 5 °C to 50 °C.

#### 4.4 Sterile cabinets and open flames

The provision of natural gas to sterile cabinets is not recommended. Open flames in the sterile cabinet create turbulences, disrupt airflow patterns and can damage the laminator and the HEPA filter. When suitable alternatives (e.g. disposable sterile loops, micro-incinerators) are not possible, touch-plate micro-burners that have a pilot light to provides a flame may be used.

#### 4.5 Moving the Fortuna cabinets

It is not recommended to move the Fortuna cabinets after installation. The moving of a cabinet can result in safety issues, which can only be detected by re-testing of critical functions and properties.

If moving is warranted both the Fortuna can be lifted and moved using a low lifter (on 1500 and 1800 models use one from each side). Be aware that the cabinets are top heavy. Stabilize cabinet during the moving process. On all Fortuna cabinets, the stand can be removed and moved separately.

	<b>Caution</b>
	Whenever transportation of the cabinet is needed, precautions should be taken to prevent it from overturning due to the high-located mass centre.

	<b>Caution</b>
	In order to prevent damage to the cabinet it must be handled as fragile goods.

#### 4.6 Connecting utilities to the Fortuna cabinets

If optional valves for utilities are delivered, make sure that local rules and regulations are complied with during installation and use. It is generally recommended, to use an authorized technician for this kind of work. Make sure that local rules and regulations regarding such installations are strictly complied to.

Valves suited for any utility medium can be delivered. As default they are mounted in the holes in the side windows. Optionally they can be mounted in the back wall.

Product name	Catalogue No.
Valve, gas	9.001.020.015
Valve, vacuum	9.001.020.016
Valve, carbon dioxide	9.001.020.017
Valve, nitrogen	9.001.020.018
Valve, compressed air	9.001.020.019
Valve, oxygen	9.001.020.020
Valve, water	9.001.020.701

## Instruction manual for Fortuna

### 5 Start-up of the Fortuna cabinets

	<b>Caution</b>
	Correct assembly and installation is essential for proper start-up and operation of the Fortuna cabinets.

#### 5.1 Preparation

	<b>Caution</b>
	The installations site for the unit must be draught-free and should be selected so that frequent passing of people in front of the work opening is avoided.

1. Adjust the levelling screws to assure that the table top is in horizontal position and levelled.
2. Valves for gases or vacuum are installed in the side windows. A qualified technician must make the connections for the supply.

When the cabinet has been installed:

1. Check that the front window is in the correct position, i.e. parallel to the front shield.
2. Never lift the front window manually - this will cause window to malfunction.
3. Check that the window slides from top to bottom without any irregular sound.
4. If the window does not move when the UP or DOWN button is pressed, authorized service personnel must be called to correct the fault.
5. Always keep hands and arms away from the working chamber when activating the front window.

#### 5.2 Connections

Required fusing: Circuit breaker 10 A (13 A) or fuse T 10 A (T 13 A).

In addition, the applicable safety requirements of the local power Supply Company shall apply.

	<b>Caution</b>
	If an automatic relay for disconnection of power in case of electric fault is needed, it must be installed in the supply, as it is not built-in.

	<b>Caution</b>
	Before connecting the power supply it must be checked that the mains specifications correspond to those stated on the type plate.

	<b>Caution</b>
	The safety cabinet is provided with a flexible power cord. The connection may be installed hard-wired or by means of a wall outlet with protective ground.

## Instruction manual for Fortuna

If a hard-wired connection is used, a main switch, which will cut off all poles to the unit, must be used. This switch must be lockable both in the ON and OFF positions.

### 5.3 Assemble the stand for the Fortuna cabinets

As default the Fortuna cabinets are delivered without the stand mounted.

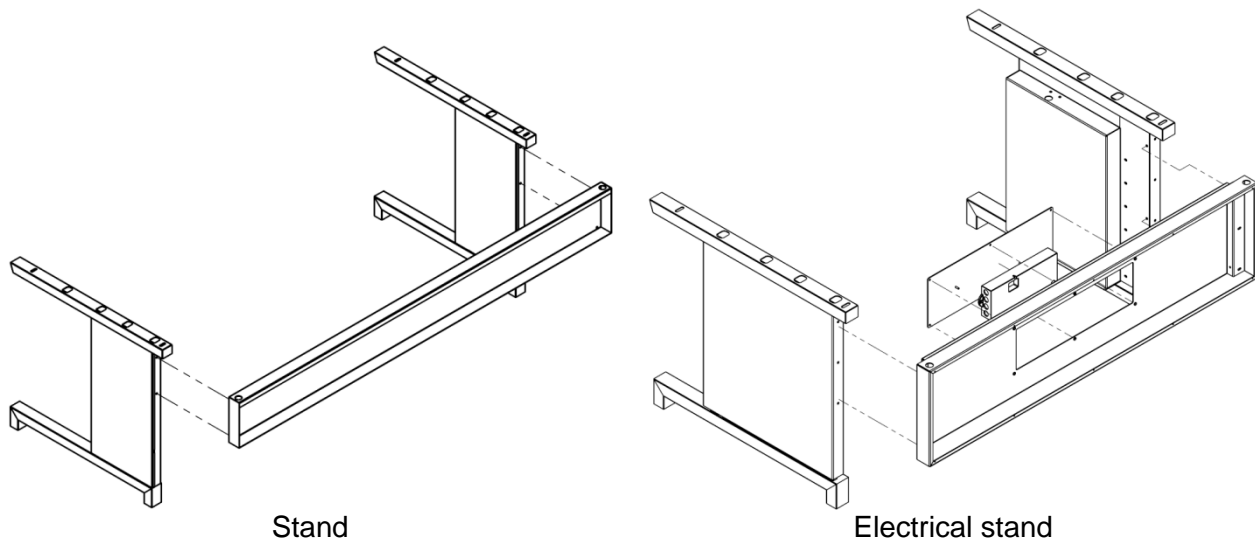

All nuts and bolts for assembly of the stand and for mounting the stand to the cabinet are delivered with the stands.

Start by assembling the stand and then place the cabinet on top and fasten with four bolts – one in each corner.

Product name	Catalogue No.
Stand, Fortuna 900, 75-80 cm	9.001.020.011
Stand, Fortuna 1200, 75-80 cm	9.001.020.012
Stand, Fortuna 1500, 75-80 cm	9.001.020.013
Stand, Fortuna 1800, 75-80 cm	9.001.020.014
Stand, Fortuna 900, 80-85 cm	9.001.040.011
Stand, Fortuna 1200, 80-85 cm	9.001.040.012
Stand, Fortuna 1500, 80-85 cm	9.001.040.013
Stand, Fortuna 1800, 75-80 cm	9.001.040.014
Stand, Fortuna 900, 90-95 cm	9.001.030.011
Stand, Fortuna 1200, 90-95cm	9.001.030.012
Stand, Fortuna 1500, 90-95cm	9.001.030.013
Stand, Fortuna 1800, 90-95 cm	9.001.030.014
Electrical stand, Fortuna 900, 75-105 cm	9.001.020.101
Electrical stand, Fortuna 1200, 75-105 cm	9.001.020.102
Electrical stand, Fortuna 1500, 75-105 cm	9.001.020.103
Electrical stand, Fortuna 1800, 75-105 cm	9.001.020.104

### 5.4 Levelling of the Fortuna cabinets

To ensure the best working conditions possible the cabinet must be levelled off before getting released for normal operation.

Place a levelling device directly on the table tops and adjust the feet on the stand until the cabinet is perfectly in horizontal level. Make sure that the cabinet is in horizontal level from side to side and from front to back.

### 5.5 Power connection of the Fortuna cabinets





The Fortuna cabinets are connected to power through the delivered power cable. It is mounted in the power inlet placed on top of the cabinet and to a standard power socket. All that is required is 230 VAC / 50 Hz connected to a 10 A or 13 A fused socket in the general electrical installation.

Product name	Catalogue No.
Power cable, DK	Delivered with the product.
Power cable, US	
Power cable, GB	Contact LaboGene if a spare is needed.
Power cable, EU	
Power cable, AUS	

### 5.6 Installation test on the Fortuna cabinets

The Fortuna cabinets must go through a series of test after installation has been finalized before being released for normal operation.

As a minimum the following tests must be performed with satisfactory results:

-  Leak test of downflow HEPA filter
-  Downflow air velocity
-  Alarm settings (downflow alarms)
-  Smoke pattern test

The above mentioned tests are all associated with the safe operation of the cabinet. General functionality is checked ad Hoc

To ensure optimal function and performance of the cabinet, the parameter values found in the Factory test report must be used as close as possible. An installation test report covering all necessary tests exists and can be acquired on demand from LaboGene.

	<b>Warning</b>
	The operational safety of the cabinet is guaranteed only, if all safety functions of the cabinet have been tested and approved.

	<b>Caution</b>
	LaboGene will not warrant the operational safety if the cabinet is operated without the required installation tests, or if these tests and are not performed by adequately trained personnel.

	<b>Caution</b>
	The initial operation with subsequent installation test does not include any decontamination measures. The working chamber and any accessories required must be disinfected and cleaned in accordance with the hygiene guidelines set forth for the desired application.







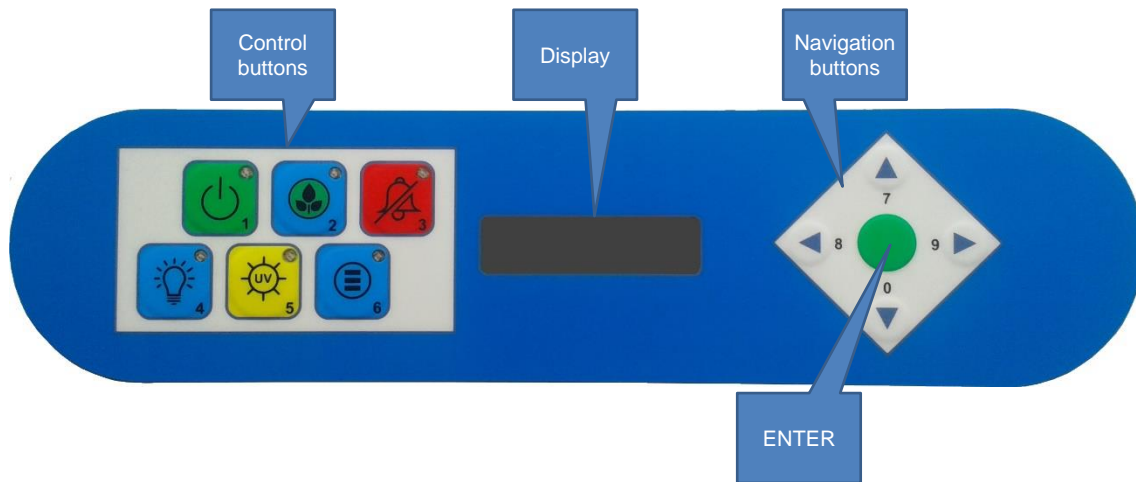



## Instruction manual for Fortuna

### 6 Operating the Fortuna cabinets

All functions are controlled via the control panel shown below and by an electronic microprocessor based control system.



The control panel contains 6 buttons with LED for operating the basic functions in the cabinet, a text display, that will show current running conditions and error messages and 5 buttons for navigational purposes.







-  Button **1** with green LED light to select the fan ON/OFF at normal velocity. The green light indicates that the fan is running at normal velocity, and that conditions are safe.
-  Button **2** with blue LED to select the fan ON/OFF at reduced velocity. Can be adjusted to any level desired for individual requirements (See Service menu).
-  Button **3** with red light to silence the acoustic alarm.
-  Button **4** with blue light for normal light ON/OFF.
-  Button **5** with yellow light is if UV light is required for decontamination or activation of the table top. The time for the light is set in the user menu (See User menu).
-  Button **6** can be connected to an internal plug in the chamber for remote on/off of the plug/gas resettable valve.
-  Button **7**: Window open (upwards movement).
-  Button **8**: Only for programming/navigation.
-  Button **9**: Only for programming/navigation.
-  Button **0**: Window close (downwards movement).
-  Blue button: ENTER.

The user can by pressing enter see following **User menu's**

-  **Light intensity** – in this menu the user can choose between 0-100 % light intensity to get best light conditions. Please choose desired level and press enter.



## Instruction manual for Fortuna

-  By pressing 8 or 9 the user can move to **Display mode** – where there is a possibility for constant read out of velocity speeds – both inflow and down – flow – showed in m/s or in counts from 0-255.
-  By pressing 8 or 9 again the user can see **UV-light** (if this is installed) and choose the time for how long the UV –light should be activated.
-  By pressing 8 or 9 again the user can choose **Auto start** – auto stop. Here it is possible to select Monday to Friday – whole week or only a single day when the cabinet should start up in full speed and after how long it should wait until it switches off again.
-  By pressing 8 or 9 the **Time setting** on the cabinet can be set by the end user – date, month, and year, clock 24 hours or AM/PM.
-  By pressing 8 or 9 **Password** shows up – this means the user can select a Password so the keys cannot be activated – without the entered Password. It can always be overruled by the Service access code.
-  By pressing 8 or 9 **Service mode** can be reached. To enter this you need to be trained personnel and to have got the Service access code.

# Instruction manual for Fortuna

## 6.1 Overview of the user menu

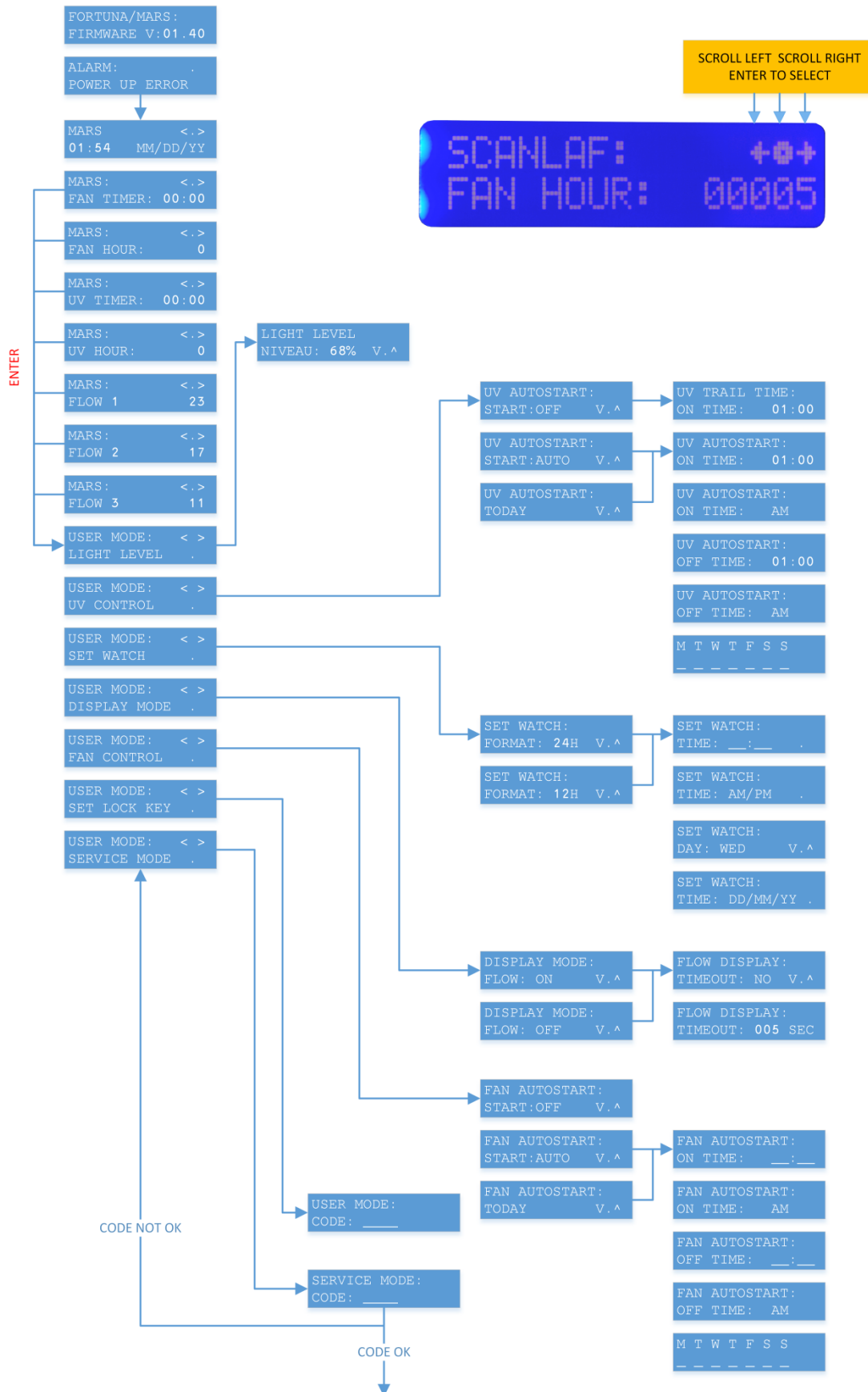





## Instruction manual for Fortuna

### 6.2 Programming

Password protected access for trained personnel only!

**Service mode:** This menu is only operated by authorised service people from LaboGene, distributors and trained technical people for safety reasons – who have got the Service access code.

In Service mode the following can be adjusted:





-  **Airflow speeds** downflow and exhaust through 2 air flow sensors.
-  The setting and calibration of the **Alarms:** Analogue air flow sensors or pressostats.
-  The configuration of the cabinet options: UV–light, light mode setting, electrical outlets, gas resettable valves, PIR sensor.
-  External control setting: Output 0-10 VDC to volume gauge, external blower dampers or CTS, input from external blower or CTS or pressure gauge mounted in the exhaust channel.
-  Decontamination through H<sub>2</sub>O<sub>2</sub> or Formalin.

### 6.3 Supervision – Alarm

The cabinet safety is constantly supervised so that any deviation from safe conditions or any fault in the supervision system will be indicated immediately.

Safe conditions are indicated by a green LED light in the button for fan at normal velocity. Unsafe conditions will be indicated both acoustically and visually by red flashing LED light.

The alarm will be initiated if:

-  The vertical air velocity inside the work area is outside the limits.
-  The air volume exhausted is below the limits.
-  The fan is running at reduced velocity.
-  After a power failure **AND** on normal start-up.
-  Optional 3<sup>rd</sup> sensor: A sensor mounted in the exhaust channel.

By activating the alarm  when the cabinet runs at reduced speed the red LED will change from flashing to constant light.

The alarm will be deactivated when the fan is running at normal velocity, all conditions are safe, or the cabinet is switched off.

(The whole display can be flashing if there is an alarm – this setting is done as a default in alarm setting).

### 6.4 PIR sensor

If the operation of the cabinet has to be automatic – i.e. the cabinets is ready to work when the operator stick the arms in the work chamber.



## Instruction manual for Fortuna

In this case a PIR sensor can be mounted – let the cabinet run at full speed for defined time – as long as there are movements. If no movements it will stop after the pre-set time from 60 seconds and up.

In order to ensure the clean environment inside the cabinet, and that the cabinet instantly provides operator safety – the cabinet has to run at reduced speed at all times during working hours (programmable through the autostart – menu).

### 6.5 Setting of light

The light setting of the cabinet upon alarm can be set in 3 different alternatives:

-  Light always on when blue light button is activated.
-  Light always on when blue light button is activated and in full speed mode – if reduced speed is pressed the light turns out.
-  Light is always on when blue light button is activated and in full speed mode – if there is an alarm the light will turn off automatically and will only be turned on again when all alarms have been deactivated.

### 6.6 Start-up of the Mars and Mars Pro cabinets

Turn on the cabinet by pressing the green button (1). The fans will start and the visible alarm in the red button (3) will flash and audible alarm will be running until safe air velocity in downflow and inflow has been reached. When the safe condition is reached the LED in the green button (1) will turn on. The display will show the message below. Press the blue ENTER button to clear this message.







Turn on the light on in the cabinet by pressing the blue button (4). Move the window to working position using the arrow UP (7) or DOWN (0) buttons.

The cabinet is ready for use with protection of product.

### 6.7 Operating modes of the Fortuna cabinets

The following are the operating modes for Fortuna cabinets:

-  OFF mode
-  Working mode
-  Standby mode
-  UV mode

#### 6.7.1 Off mode

Off mode means the cabinet is in an idle state. The cabinet is turned off (light and fans are off). The cabinet is connected to a power source.

## Instruction manual for Fortuna

### 6.7.2 Working mode (Operating mode)

In normal operation mode or working mode no alarms can be active. In this case it is safe to work in the cabinet, product, operator and environment is protected. The green LED in button (1) is on and the blue LED in button (4) is on. The display is showing the message below:



Or the screen, shown below, depending on the setup of the cabinet control system:



### 6.7.3 Standby mode

To enter standby mode press the blue button (2). The fans will go to reduced speed – approximately 50% of the normal operating speed, the light will turn off and the audible and visible alarm (red button (3)) will activate. The audible alarm can be muted by pressing the red button (3).

It is not safe to work in the cabinet in this mode.

To return to working mode just press the green button (1).

### 6.7.4 UV mode

To enter UV mode press the yellow button (5). UV mode can only be activated when the window is completely closed. The light is switched off in the cabinet during the UV disinfection period. The UV period is controlled by a timer integrated in the control system.

The user can enter a time for the UV light to be switched on and the duration of the UV disinfection period.

Please remember that UV light does not penetrate areas blocked from the direct light and that it does not represent a substitute for good old fashion mechanical cleaning of the inner surfaces of the safety cabinet.







## 6.8 Loading the working chamber

1. Turn on the cabinet. Move the front window to the maximum opening position.
2. Install needed work materials within the working chamber work area. Avoid blocking the inflow air intake.
3. Move the front window to the work position and wait for the airflow to stabilize. Safe working conditions are reached when the alarm is deactivated and the green LED in button 1 is on.
4. Load the work tray with samples and place them inside the working chamber.
5. For work breaks or for extended experimental phases without manual intervention, switch the device to standby mode by pressing button 2.

## Instruction manual for Fortuna









### 6.9 Working safely - Recommendations

#### 6.9.1 Before start-up

-  The cabinets may only be operated at temperatures between 15 °C and 35 °C, at maximum 80% relative humidity, and at normal air pressure.
-  Approximately 15 minutes before any work in the cabinet, the fan of the unit must be switched on at normal velocity.
-  The work chamber and the front- and side windows are to be carefully cleaned and disinfected. Use an ethanol solution or similar. It is recommended to use special lint-free material. Do not use explosive disinfectants.
-  Objects and appliances must be carefully cleaned or disinfected before being introduced into the work chamber. Do not bring in writing utensils, packing material, etc.
-  The front window is positioned in working position and kept in that position during the entire work process.
-  Necessary appliances for use during work must be placed within easy reach.
-  Secure the appropriate protection of the operator as well as the product (e.g. clothes, gloves, etc.).

#### 6.10 While working



	<b>Caution</b>
	Important for work with environmentally harmful substances!

-  Do not perform work while the fan is running at reduced speed.
-  The front window must be in work position.
-  Place the product behind the perforated area of the work surface.
-  Work with calm, smooth movements.
-  Never overload the work chamber.
-  Reduce the number of transfers into and out of the work chamber.
-  Avoid equipment with high heat emission.
-  Avoid a cabinet location where personnel frequently pass avoid draughts.

	<b>Caution</b>
	The efficiency of the laminar airflow in the work chamber is essential for product protection. Negative influences of the flow conditions must therefore be avoided.

They are primarily raised due to:

## Instruction manual for Fortuna

-  Rapid movements of the operator's hand, arm, or body both in and in front of the work chamber.
-  Large objects and apparatus.
-  Devices making rapid movements, e.g. agitators, centrifuges.

	<b>Caution</b>
	Do not damage the laminator or the main filter in the ceiling of the work chamber by mechanical objects or heat sources, otherwise the microbiological safety is no longer ensured.

The acoustic and optical monitoring devices of the fan and front window must not be deactivated.

Devices developing strong heat e.g. burners which can disrupt airflows. If burners cannot be avoided, use safety burners.

Operate heat sources only with the cabinet fan activated.

### 6.10.1 After work

Remove objects and appliances from the work chamber.

Clean the work chamber, remove fluids, if any, from the trough and dry it. Disinfect if required. Leave the cabinet fan in operation for about another 10 minutes.

Close the front window to its lowest position.

### 6.11 Interrupting an ongoing procedure

To interrupt a work process:

1. Remove all samples from the working chamber and store them properly.
2. Remove any accessories from the chamber, and clean and disinfect them.
3. Clean and disinfect the working chamber surfaces, work tray, and the trough.
4. Turn the cabinet either to standby mode or off mode.

### 6.12 Shut down of the Fortuna cabinets

If the cabinet is not to be used or is to be stored for an extended period of time, it must be completely decontaminated.

	<b>Warning</b>
	To shut the cabinet down, the sample chamber must be disinfected completely and the plenum, including the filters, must be decontaminated using the appropriate and authorized procedures.

1. After the device has been decontaminated, close the window completely.
2. Disconnect the unit from the power source.

## Instruction manual for Fortuna

### 6.13 Disposal of cabinets

All components except for the HEPA filter can be discarded after having been thoroughly cleaned and decontaminated. The HEPA filter must be discarded in accordance with the applicable international, national and local regulations for chemical or biological waste.

	<p><b>Warning</b></p> <p>As this cabinet can be used for processing and treating infectious substances, it must be decontaminated prior to disposal, in accordance with acceptable standards and procedures.</p>
---	--

## 7 Cleaning/Decontamination of cabinets

Several procedures can be used for decontaminating the biological safety cabinet. Which procedure is selected, depends on the potential risk imminent in the products handled, and/or the degree of cleanliness required by an experiment or work process.

One possible decontamination procedure is to clean, rinse and dry with a disinfection liquid or spray, and sterile distilled water.

UV disinfection can also be used. It is particularly suited as a more intense disinfection after the above procedure.

Decontamination using hydrogen peroxide H<sub>2</sub>O<sub>2</sub> can be performed if a sterile working chamber is required for the work procedure. This decontamination procedure or a similar one is required before filters are replaced, or before the cabinet is discarded. The control system incorporates a procedure for this process.

Decontamination using formaldehyde can be performed if a sterile working chamber is required for the work procedure. This decontamination procedure or a similar one is required before filters are replaced, or before the cabinet is discarded. The control system incorporates a procedure for this process.

### 7.1 Caring for and cleaning of stainless steel

Stainless steel is a combination of many different metals including iron and chromium. Iron, the primary element in stainless steel, tends to corrode (rust) when in its natural state. The chromium content in stainless steel prevents corrosion.

Stainless steel is not corrosion or rust proof, just resistant to stains, or stains "less". The chromium, in the presence of oxygen, forms a tough, invisible, passive layer of chromium oxide film on the steel surface. If damaged mechanically or chemically, this film is self-healing as long as it has enough oxygen. The presence of any liquid or solid that remains in contact with the stainless steel for a prolonged time can prevent oxygen contact and promote corrosion, as can prolonged contact with cleaners or disinfectants containing chlorine, ammonia, iodine or other caustic agents.

1. To properly care for stainless steel, use cleaners and disinfectants free of caustic agents such as chlorine, iodine and ammonia.
2. Always follow the application of any cleaner or disinfectant with a minimum of two clean distilled water rinses, then a thorough drying with a clean soft cloth. By rinsing with distilled water and drying, any remaining residue is removed from contact with the stainless steel.



	<b>Caution</b>
	Never use abrasive cleaners, scouring pads or steel wool when caring for stainless steel.

If the stainless steel does become stained, corroded or rusted, the iron deposits left on the surface can be removed by neutralizing them with the passivation process. This process uses an acid to neutralize the “free iron” deposits left on the steel where there has been deprivation of oxygen. This stops the spread of the corrosion or rust. It will not return the stainless steel to its original finish.

## 7.2 Caring for and cleaning of coated surfaces

All the coated surfaces of these cabinets are powder coated. Powder coating is a method of applying a dry powder to electro-statically charged metal, then baked in an oven where the dry powder molecules are melted and fused together. This is by far the most durable finish available today and, if cared for properly, will last for many years. The coated surfaces should be cleaned with a neutral detergent and rinsed twice with clean distilled water, then dried thoroughly with a clean soft cloth. Cleaning or disinfecting coated surfaces without rinsing with clean distilled water and drying thoroughly will result in smearing, streaking and dulling of the coated surfaces. Never use abrasive cleaners, scouring pads or steel wool. If the coated surfaces do become dull, streaked, smeared or marred in some other way, there is no known method to restore the finish.

## 7.3 Disinfection of working chamber

1. Remove all samples from the working chamber and store them properly.
2. Remove accessories from the cabinet and disinfect them using the disinfection procedure recommended by the manufacturer of the accessory.
3. Clean all the working chambers surfaces with disinfectant. Do not use sharp objects or fluid on the laminator.

## 7.4 Rinsing of working chamber

After disinfection of the working chamber, the working chamber must be rinsed properly:

1. Rinse all surfaces of the working chamber twice with clean distilled water.
2. Dry all working chamber surfaces completely.

## 7.5 UV Disinfection after cleaning the working chamber

UV disinfection can be performed by using the optional factory installed UV light.

To start the UV disinfection procedure:

1. Close the front window.
2. Press the yellow button (5). The pre-programmed UV settings will be performed.

To interrupt or cancel the UV disinfection procedure, just press the yellow button (5) again.

## 7.6 Microbiological decontamination

Microbiological decontamination is required before accessing any area of the cabinet, which can potentially be contaminated. Typically it is required before maintenance work and change of HEPA filter. The control system can handle decontamination using hydrogen peroxide and formalin. All national and local rules and regulations must be strictly observed during this process.

## Instruction manual for Fortuna

### 7.7 Cleaning of external surfaces

Clean the exterior surfaces of the cabinet using a solution of tepid water and commercially available mild dishwashing agent. Then, dry all surfaces well, using a soft, clean cloth.

### 7.8 Cleaning the windows

For cleaning the front and side windows, use a commercially available window cleaner.

## 8 Service and maintenance of Fortuna cabinets

These cabinets are only safe as long as they are working properly. All components must be in full working order to ensure safety for product, operator and environment.

	<b>Caution</b>
	Every 5000 operating hours or at least once every year the cabinet has to be inspected and tested by a trained technician.



To ensure this, at least a yearly service and maintenance inspection is highly recommended. This activity must be carried out by trained technicians and all appropriate safety measures must be taken during this work.

	<b>Caution</b>
	Before repair work is carried out inside the contaminated and/or infected cabinet and prior to filter replacement and upon change of location, proper cleaning and disinfecting by the operator is required. The lab Manager/Safety Manager must confirm this in writing to the service personnel.

	<b>Warning</b>
	Always disconnect the mains supply before doing any work on the electrical parts of the cabinet. Failing this may cause electrical shock and damage to the electrical components.

Before starting any service and maintenance work on the cabinet, conduct a general inspection to evaluate the state of the cabinet.

After completion of the service and maintenance work, tests are required according to the standard.

-  Leakage test of downflow filter.
-  Test and adjustment of air velocities in downflow and alarm settings in the vertical downflow inside the working chamber.
-  Test of air flow patterns.







The general function and safety tests must be performed in accordance with local requirements. For this purpose we recommend a service and maintenance agreement.

All maintenance and repair work performed, as well as filter replacements and required tests, must be documented in a test book.

## Instruction manual for Fortuna





### 8.1 Service on Fortuna cabinets

Service comprises the following activities:

-  General evaluation of the state of the cabinet.
-  Check and if necessary replacement of light tubes (normal and UV if mounted).
-  Leak test of HEPA filter.
-  Check and adjustment of downflow air velocity and downflow alarms.
-  Check of window alarm.
-  Check of airflow pattern using smoke.

A service test report should be issued documenting the “as left” conditions of the cabinet.

Optional test can be performed on request:

-  Particle test in the working chamber to determine the air quality.
-  Sound level test.
-  Light intensity test – normal light.
-  Light intensity test – UV light.

### 8.2 Working chamber lights, replacement

The general light for the working chamber consists of two fluorescent light tubes placed between the downflow filter and the laminator at the top of the working chamber.

To remove the laminator, the two fixing screws, shown on the picture below, must be removed.



Remove the laminator located in top of the work chamber (handle with care). Release the two lamps from the fixtures by rotating them 90°. Install the new lamps performing the inverse operation.

Product name	Catalogue No.
Light tube Fortuna 900	9.000.040.011
Light tube Fortuna 1200	9.000.040.012
Light tube Fortuna 1500	9.000.040.013
Light tube Fortuna 1800	9.000.040.014

### 8.3 Optional UV lights

The UV light is located on the top front wall of the working chamber. Release lamps from the fixtures by rotating it 90°. Install the new UV-lamp performing the inverse operation.

	<b>Note</b>
	Use gloves when manipulating a germicidal UV lamp, to prevent leaving hand prints that reduce the effects of the ultraviolet radiation.

Replace UV lamp every 2000 or 3000 hours of life.

Product name	Catalogue No.
UV light tube, all models	9.000.040.001

### 8.4 Replacement of fuses

All fuses are located on PCB's accessed through the top plate located on the front top of the cabinet. Make sure that power is cut before removing the protective top plate.

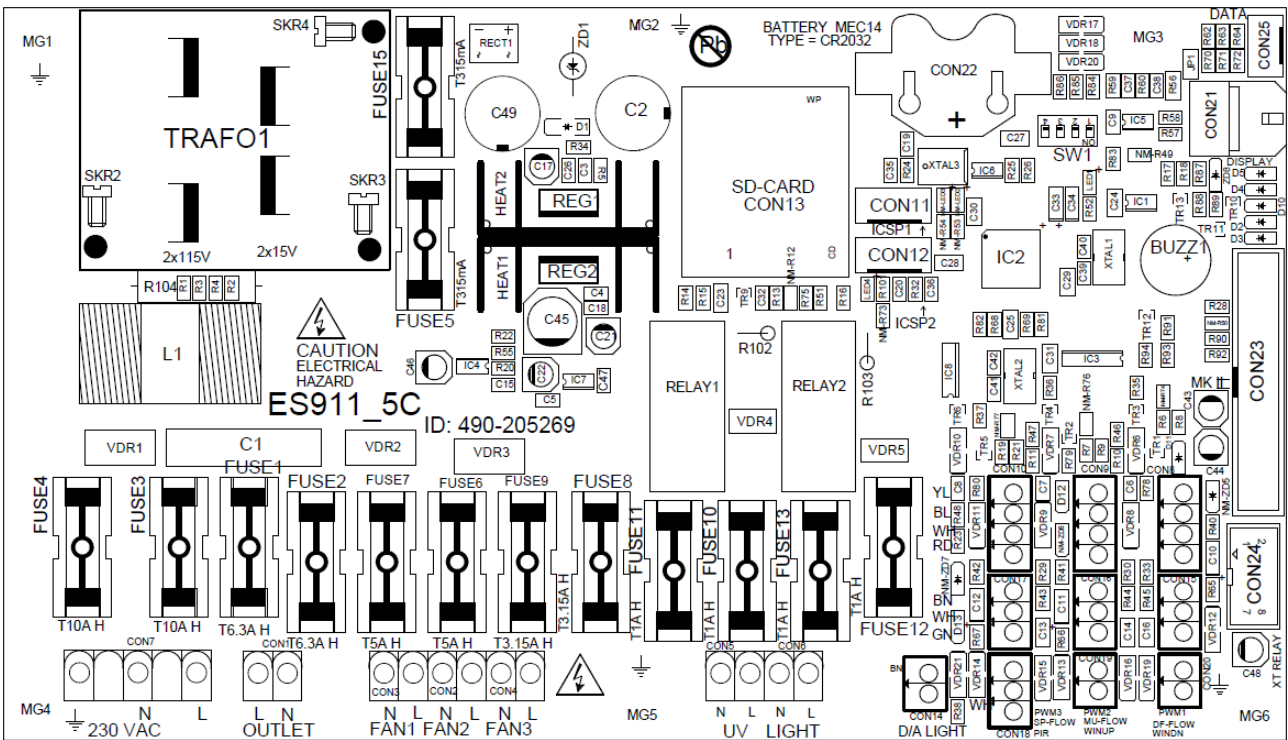

Main board

## Instruction manual for Fortuna

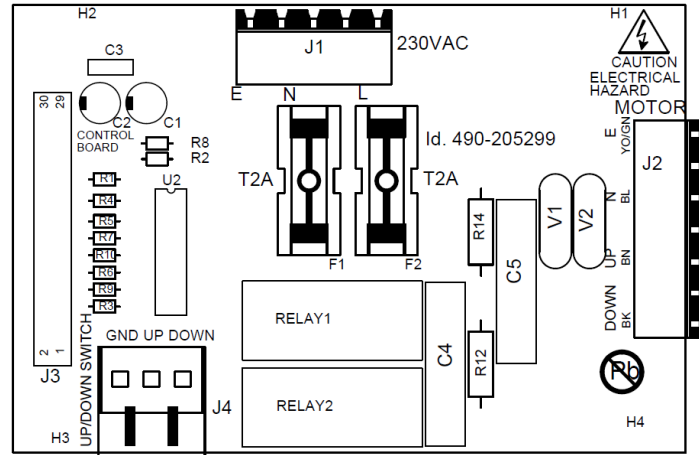

**Window motor board**

### 8.5 Replacement of laminator

The laminator is placed at the top of the working chamber just below the main downflow filter. To remove the laminator, the two fixing screws, shown on the picture below, must be removed.

Pull on the two flaps located at the back edge of the laminator and pull downwards. Be careful not to damage the main downflow filter located just above the laminator.

Install the replacement laminator and mount the fixing screws again.



Product name	Catalogue No.
Laminator Fortuna 900	9.000.071.001
Laminator Fortuna 1200	9.000.071.002
Laminator Fortuna 1500	9.000.071.003
Laminator Fortuna 1800	9.000.071.004

### 8.6 Replacements and repairs

All replacement and repairs – other than the two described above – must be performed by a trained service technician. Any retro-fitting of optional equipment

### 8.7 Disposal of cabinet

The entire cabinet except for the HEPA filter can be discarded after having been thoroughly cleaned and decontaminated. The HEPA filter must be discarded in accordance with the applicable national and local regulations for chemical and biological waste.

	Warning
	As this cabinet can be used for processing and treating infectious substances, it may become contaminated. Prior to disposal, the entire cabinet with filters must be decontaminated in accordance with acceptable standards and procedures.

## 9 Specifications

Fortuna 900	Unit	Part no: 702904
<b>General Specifications</b>		
Certificates		None
Compliance with		ISO 14644, EN 61010-1, EN 61000-6, EN 11201
Sound Pressure Level at factory settings and standard configuration	dB(A)	≤45
Sound Pressure Level in Eco-Save mode	dB(A)	≤42
Down flow, Air velocity	m/s	0,32 ±0,01
Light illuminance (fluorescent tube)	Lux	> 1000
Front Opening (height)	mm	350 (Optionally 550)
Table top		Flat, one piece
Filter construction in accordance with EN 1822-1		1-filter system, HEPA, at least Class H14
Table top and trough material		AISI 304 stainless steel
Table top max. total load	kg	100
Side glass material		5 mm hardened glass
Front glass material		6 mm laminated safety glass
Cabinet and back wall material/colour		Polyester coated steel/RAL 9016
<b>Dimensions</b>		
External dimensions with adjustable Stand (Standard) (DxWxH)	mm	797 x 1004 x 2033
Table top height with adjustable Stand (Standard)	mm	750 (Range 745-780)
External dimensions with Elec. Elevation Stand (DxWxH)	mm	797 x 1004 X 2025-2325
Table top height with Elec. Elevation Stand	mm	750-950
Work chamber dimensions (DxWxH)	mm	650x900x700
Net weight	kg	157
Shipping Volume	m <sup>3</sup>	Approx. 2,2
<b>Electrical Data</b>		
Rated AC Voltage/frequency	V/Hz	220-240/50-60
Rated max. current (fuse)	A	Max. 10
Power outlet(s) max. total current (fuse)	A	6,3
Type of power outlet socket, pair left & pair right side		DK - type K (IP44)
Typical power consumption excl. power outlets	VA/W	57/52
Typical power consumption in Eco-Save mode	VA/W	30/21
Type of mains connection		3 pin male AC power socket

## Instruction manual for Fortuna

<b>Fortuna 1200</b>	<b>Unit</b>	<b>Part no: 702905</b>
<b>General Specifications</b>		
Certificates		None
Compliance with		ISO 14644, EN 61010-1, EN 61000-6, EN 11201
Sound Pressure Level at factory settings and standard configuration	dB(A)	≤47
Sound Pressure Level in Eco-Save mode	dB(A)	≤42
Down flow, Air velocity	m/s	0,32 ±0,01
Light illuminance (fluorescent tube)	Lux	> 2000
Front Opening (height)	mm	350 (Optionally 550)
Table top		Flat, one piece
Filter construction in accordance with EN 1822-1		1-filter system, HEPA, at least Class H14
Table top and trough material		AISI 304 stainless steel
Table top max. total load	kg	100
Side glass material		5 mm hardened glass
Front glass material		6 mm laminated safety glass
Cabinet and back wall material/colour		Polyester coated steel/RAL 9016
<b>Dimensions</b>		
External dimensions with adjustable Stand (Standard) (DxWxH)	mm	797 x 1304 x 2033
Table top height with adjustable Stand (Standard)	mm	750 (Range 745-780)
External dimensions with Elec. Elevation Stand (DxWxH)	mm	797 x 1304 X 2025-2325
Table top height with Elec. Elevation Stand	mm	750-950
Work chamber dimensions (DxWxH)	mm	650x1200x700
Net weight	kg	192
Shipping Volume	m <sup>3</sup>	Approx. 2,9
<b>Electrical Data</b>		
Rated AC Voltage/frequency	V/Hz	220-240/50-60
Rated max. current (fuse)	A	Max. 10
Power outlet(s) max. total current (fuse)	A	6,3
Type of power outlet socket, pair left & pair right side		DK - type K (IP44)
Typical power consumption excl. power outlets	VA/W	100/92
Typical power consumption in Eco-Save mode	VA/W	50/35
Type of mains connection		3 pin male AC power socket

## Instruction manual for Fortuna

<b>Fortuna 1500</b>	<b>Unit</b>	<b>Part no: 702906</b>
<b>General Specifications</b>		
Certificates		None
Compliance with		ISO 14644, EN 61010-1, EN 61000-6, EN 11201
Sound Pressure Level at factory settings and standard configuration	dB(A)	≤49
Sound Pressure Level in Eco-Save mode	dB(A)	≤42
Down flow, Air velocity	m/s	0,32 ±0,01
Light illuminance (fluorescent tube)	Lux	> 2000
Front Opening (height)	mm	350 (Optionally 550)
Table top		Flat, one piece
Filter construction in accordance with EN 1822-1		1-filter system, HEPA, at least Class H14
Table top and trough material		AISI 304 stainless steel
Table top max. total load	kg	100
Side glass material		5 mm hardened glass
Front glass material		6 mm laminated safety glass
Cabinet and back wall material/colour		Polyester coated steel/RAL 9016
<b>Dimensions</b>		
External dimensions with adjustable Stand (Standard) (DxWxH)	mm	797 x 1609 x 2033
Table top height with adjustable Stand (Standard)	mm	750 (Range 745-780)
External dimensions with Elec. Elevation Stand (DxWxH)	mm	797 x 1609 X 2025-2325
Table top height with Elec. Elevation Stand	mm	750-950
Work chamber dimensions (DxWxH)	mm	650x1500x700
Net weight	kg	227
Shipping Volume	m <sup>3</sup>	Approx. 3,2
<b>Electrical Data</b>		
Rated AC Voltage/frequency	V/Hz	220-240/50-60
Rated max. current (fuse)	A	Max. 10
Power outlet(s) max. total current (fuse)	A	6,3
Type of power outlet socket, pair left & pair right side		DK - type K (IP44)
Typical power consumption excl. power outlets	VA/W	123/113
Typical power consumption in Eco-Save mode	VA/W	55/39
Type of mains connection		3 pin male AC power socket



## Instruction manual for Fortuna

<b>Fortuna 1800</b>	<b>Unit</b>	<b>Part no: 702907</b>
<b>General Specifications</b>		
Certificates		None
Compliance with		ISO 14644, EN 61010-1, EN 61000-6, EN 11201
Sound Pressure Level at factory settings and standard configuration	dB(A)	≤52
Sound Pressure Level in Eco-Save mode	dB(A)	≤42
Down flow, Air velocity	m/s	0,32 ±0,01
Light illuminance (fluorescent tube)	Lux	> 2000
Front Opening (height)	mm	350 (Optionally 550)
Table top		Flat, one piece
Filter construction in accordance with EN 1822-1		1-filter system, HEPA, at least Class H14
Table top and trough material		AISI 304 stainless steel
Table top max. total load	kg	100
Side glass material		5 mm hardened glass
Front glass material		6 mm laminated safety glass
Cabinet and back wall material/colour		Polyester coated steel/RAL 9016
<b>Dimensions</b>		
External dimensions with adjustable Stand (Standard) (DxWxH)	mm	797 x 1914 x 2033
Table top height with adjustable Stand (Standard)	mm	750 (Range 745-780)
External dimensions with Elec. Elevation Stand (DxWxH)	mm	797 x 1914 X 2025-2325
Table top height with Elec. Elevation Stand	mm	750-950
Work chamber dimensions (DxWxH)	mm	650x1800x700
Net weight	kg	262
Shipping Volume	m <sup>3</sup>	Approx. 4,1
<b>Electrical Data</b>		
Rated AC Voltage/frequency	V/Hz	220-240/50-60
Rated max. current (fuse)	A	Max. 10
Power outlet(s) max. total current (fuse)	A	6,3
Type of power outlet socket, pair left & pair right side		DK - type K (IP44)
Typical power consumption excl. power outlets	VA/W	142/131
Typical power consumption in Eco-Save mode	VA/W	75/53
Type of mains connection		3 pin male AC power socket

## 9.1 Spare parts

Cat. No.	Item
9.000.040.001	UV-light tube for Fortuna 900-1800
9.000.040.011	Light tube for Fortuna 900
9.000.040.012	Light tube for Fortuna 1200
9.000.040.013	Light tube for Fortuna 1500
9.000.040.014	Light tube for Fortuna 1800
9.000.050.001	Main HEPA filter for Fortuna 900 - 915x457x115 mm
9.000.050.002	Main HEPA filter for Fortuna 1200 - 1220x457x115 mm
9.000.050.003	Main HEPA filter Fortuna 1500 - 1525x457x115 mm
9.000.050.004	Main HEPA filter Fortuna 1800 - 1830x457x115 mm
9.000.050.115	Main circuit board for Fortuna
9.000.050.006	Flow sensor
9.000.050.007	Light ballast for Fortuna 900 and 1200
9.000.050.008	Light ballast for Fortuna 1500 and 1800
9.000.050.009	Window motor for Fortuna
9.000.050.112	Display board Fortuna
9.000.050.011	Motor board Fortuna
9.000.050.010	UV-light ballast Fortuna
9.000.050.014	Fan for Fortuna
9.000.071.001	Laminator for Fortuna 900
9.000.071.002	Laminator for Fortuna 1200
9.000.071.003	Laminator for Fortuna 1500
9.000.071.004	Laminator for Fortuna 1800
9.000.050.024	Microswitch for Fortuna window
9.000.050.025	Front window Fortuna 900
9.000.050.026	Front window Fortuna 1200
9.000.050.027	Front window Fortuna 1500
9.000.050.028	Front window Fortuna 1800
9.000.050.033	Gas damper for the front cover for Fortuna, all models
9.000.072.004	DOP valve
9.000.021.134	ULPA-filter with gel for Fortuna 900
9.000.021.135	ULPA-filter with gel for Fortuna 1200
9.000.021.136	ULPA-filter with gel for Fortuna 1500
9.000.021.137	ULPA-filter with gel for Fortuna 1800

## Instruction manual for Fortuna

### 10 Quality testing of the Fortuna cabinets

All Fortuna cabinets are adjusted and tested before leaving the factory. A factory check list and a factory test report is issued for each cabinet and is, together with the HEPA filter test certificates and an instruction manual, shipped with the cabinet.

#### 10.1 Test terms and definitions

Nominal value	Default value as specified by LaboGene.
Measured value	Value measured at the location of the sterile cabinet.
Tolerance	Acceptable deviation from the nominal value.
Average value	The sum of the measuring values divided by the number of tests. The average value is compared to the nominal value.
Set point	Acceptable operating value for the downflow air velocity.
Downflow air velocity	Velocity of the displacement airflow circulating through the working chamber.

#### 10.2 What is required by EN 12469 to be tested

Test	Factory	Installation	Service
Leak test of HEPA filters	Yes	Yes	Yes
Downflow air velocity and setting of alarms	Yes	Yes	Yes
Test of alarms	Yes	Yes	Yes
Light test	Yes	Yes	
Airflow pattern test	Yes	Yes	Yes
Electrical test	Yes		
<b>Special tests not included as default</b>			
Particle counting in working chamber		Yes	
UV light intensity		Yes	
Sound test		Yes	

#### 10.3 The factory quality test of the Fortuna cabinets

The factory quality test of the cabinets is designed to ensure that the cabinet is functioning in accordance with requirements and specification before being shipped to the customer.

#### 10.4 The factory check list and factory test report

The factory check list and factory test report is designed for the Fortuna cabinets specifically. They document all quality related activities performed during the production through testing and cleaning when the cabinet is ready for packing and shipment.

A filled in and reviewed check list and test report is shipped with each cabinet.

#### 10.5 Test equipment needed to perform installation tests and service tests

The test equipment needed to perform installation and service test are:

## Instruction manual for Fortuna

Test	Equipment
Leak test of HEPA filter	Smoke generator and aerosol photometer or particle counter
Downflow air velocity and setting of alarms	Thermo-anemometer
Test of alarms	No equipment needed
Light test	Light meter
Airflow pattern test	Smoke stick or similar

All equipment used should be of a suitable quality and should be calibrated where deemed necessary in compliance with EN 12469.

### 10.6 Test information

For more detailed information on the individual tests please refer to the factory test report delivered with the cabinet.

During installation and service testing, the values measured during the factory test are the target values to be reached as close as possible.

From the factory all parameters and functions has been set to ensure that all requirements are meet and that the cabinet will protect the samples handled, the operator doing the work and the environment in the surrounding room.

All tests should be done by authorized test technician approved by LaboGene.

## 11 Options for Fortuna cabinets

A number of optional components can be fitted to the Fortuna cabinets.

The cabinets can be ordered with these options or the options can be retro-fitted by trained service technicians.

The most common options are listed below. Contact your distributor or LaboGene for availability of other options.

### 11.1 LED light

As an option to the traditional fluorescent light tubes, LED light can be fitted. Two versions exists a non-dimmable and a dimmable.

The use of LED light will save on energy but will still give a good working light with approximately the same intensity as the traditional fluorescent light tubes. The LED light requires installation of a special ballast.

Product name	Catalogue No.
LED Fortuna 900	9.001.020.866
LED Fortuna 1200	9.001.020.867
LED Fortuna 1500	9.001.020.868
LED Fortuna 1800	9.001.020.869
LED dimmable Fortuna 1200	9.001.020.863
LED dimmable Fortuna 1500	9.001.020.864
LED dimmable Fortuna 1800	9.001.020.865

## Instruction manual for Fortuna

### 11.2 PIR sensor

PIR sensor can be delivered or retro-fitted by a qualified technician.

Product name	Catalogue No.
PIR sensor - turns automatically to full speed and light upon any movement	9.001.000.087

### 11.3 Utility valves

Utility valves are mounted in the side windows as default. The connection to the utility supplies cannot be done by LaboGene.

If optional valves for utilities are delivered, make sure that local rules and regulations are complied with during installation and use. It is generally recommended, to use an authorized technician for this kind of work. Make sure that local rules and regulations regarding such installations are strictly complied to.

Valves suited for any utility medium can be delivered.

Optionally they can be mounted in the back wall.

Product name	Catalogue No.
Valve, gas	9.001.020.015
Valve, vacuum	9.001.020.016
Valve, carbon dioxide	9.001.020.017
Valve, nitrogen	9.001.020.018
Valve, compressed air	9.001.020.019
Valve, oxygen	9.001.020.020
Valve, water	9.001.020.701

## 12 Annex 1 - Factory check list and factory test report

<b>Sterile UDF Cabinet</b>	<b>Factory Check List Fortuna 900,1200,1500,1800</b>	 LABOGENE Scandinavian by Design
----------------------------	--	--

<b>Type of cabinet:</b>	
<b>Serial number:</b>	
<b>Made by:</b>	
<b>Order number:</b>	
<b>Customer:</b>	
<b>Cabinet voltage and frequency:</b>	

<b>Factory checklist and test report reviewed by:</b> Fabriks-checkliste og testrapport kontrolleret af:	
<b>Date of review:</b> Dato for kontrol:	
<b>Check list and report - all accepted:</b> Checkliste og rapport - alt accepteret:	Yes <input type="checkbox"/> No <input type="checkbox"/>

10550X

xxxx2015QA01

Page 1 of 9

<b>Sterile UDF Cabinet</b>	<b>Factory Check List Fortuna 900,1200,1500,1800</b>	
----------------------------	--	---

<b>Test Technician / Tekniker</b>			
	Pass	Fail	N/A
<b>Check all window functions:</b> Check vinduesfunktioner:			
<b>Check light functions always set in safe mode:</b> Check lysfunktioner altid i safe mode:			
<b>Check UV-light in safe mode:</b> Check UV-lys i safe mode:			
<b>Check electrical sockets phase/neutral/earth:</b> Check stik er korrekt monteret fase/nul/jord:			
<b>Smooth start-up of fans:</b> Jævn start af ventilatorer:			
<b>Check cable bushings:</b> Check kabelgennemføringer:			
<b>Check PIR-sensor function, fan and lights in safe mode:</b> Check PIR-Sensor funktion, blæser og lys i safe mode:			
<b>Check solenoid gas valve function:</b> Check magnetventil funktion for gas:			
<b>UK fuses and labels:</b> UK sikringer og labels:			
<b>Check that cabinet is according to the order:</b> Check kabinet er i overensstemmelse med ordren:			
<b>Checked by date/signature:</b> Checket af dato/signatur:			

<b>Sterile UDF Cabinet</b>	<b>Factory Check List Fortuna 900,1200,1500,1800</b>	
----------------------------	--	---

<b>Cleaning / Rengøring</b>			
	Pass	Fail	N/A
<b>Check windows for defects:</b> Check ruder for skader:			
<b>Check all silicone seal:</b> Check siliconefuger:			
<b>Check damper for lamp shade:</b> Check gasdæmper for lampeskærm:			
<b>Check plastic plugs in side windows:</b> Check plasticpropper i sidevinduer:			
<b>Check that the laminator is correctly mounted and with locking screw:</b> Check at laminator er korrekt monteret og med låseskruer:			
<b>Check retaining clamp on power inlet:</b> Check sikkerhedsbøjle på netbrønd:			
<b>Cleaning of surfaces, window and trough:</b> Rengøring af overflader, ruder og trug:			
<b>Check name plate and test label:</b> Check Typeskilt og testlabel:			
<b>Check order:</b> Check ordre:			
<b>Check factory test report is correctly filled and signed:</b> Check fabrikketrapporten er korrekt udfyldt og signeret:			
<b>Checked by date/signature:</b> Checket af dato/signatur:			



<b>Sterile UDF Cabinet</b>	<b>Factory Check List Fortuna 900,1200,1500,1800</b>	
----------------------------	--	---

Builder / Montør			
	Pass	Fail	N/A
Check of internal checklist: Intern checklist gennemgået:	<input type="checkbox"/>	<input type="checkbox"/>	<input type="checkbox"/>
Checked by Date / Signature: Checket af Dato / Signatur:			

Builder / Montør			
	Pass	Fail	N/A
Check for sharp edges on table top/table tops: Check for skarpe kanter på bordplade/bordplader:	<input type="checkbox"/>	<input type="checkbox"/>	<input type="checkbox"/>
Check top plate is mounted: Check topplade monteret:	<input type="checkbox"/>	<input type="checkbox"/>	<input type="checkbox"/>
Checked by date /signature: Checket af dato /signatur:			

<b>Sterile UDF Cabinet</b>	<b>Factory Test Report Fortuna 900,1200,1500,1800</b>	 <b>LABOGENE</b> Scandinavian by Design
----------------------------	---	---

<b>Serial No.</b>	
<b>Model / Size:</b>	
<b>Order No.</b>	
<b>Customer:</b>	

**Important:**

Let the cabinet run for 30 minutes with light on, before measurement, all measurements, listed in this report, must be carried out for factory testing.

<b>Main fans:</b>	Serial no:	Date/signature:
	Serial no:	
<b>Controller board PCB:</b>	Serial no:	Date/signature:
	Software version no.:	Date/signature:
<b>Display board:</b>	Software version no.:	

<b>Sterile UDF Cabinet</b>	<b>Factory Test Report Fortuna 900,1200,1500,1800</b>	 <b>LABOGENE</b> Scandinavian by Design
----------------------------	---	---

**Leak test  
Main filter.  
Instrument used: Aerosol photometer.  
According to Annex D in EN 12469.  
Filter certificates according to EN 1822 must be present and attached to this report.**

<b>Main filter</b>		
<b>Make:</b>	<b>Size:</b>	<b>x457x115/ H14</b>
<b>Serial no.</b>		
<b>Aerosol concentration <math>\geq 10 \mu\text{g/l}</math></b>		<input type="checkbox"/> Pass <input type="checkbox"/> Fail
<b>Leakage scanning <math>&lt; 0,01\%</math></b>		<input type="checkbox"/> Pass <input type="checkbox"/> Fail
<b>Date/signature:</b>		
<b>Aerosol Photometer ID-no:</b>		
<b>Calibration date:</b>		

<b>Sterile UDF Cabinet</b>	<b>Factory Test Report Fortuna 900,1200,1500,1800</b>	
----------------------------	---	---

<b>Air velocity in laminar flow According to Annex G EN 12469</b>							
Down flow is measured in at least <b>8</b> positions in horizontal plane <b>50 - 100</b> mm over top edge of the window opening. minimum <b>4</b> positions <b>125</b> mm from the back wall and <b>4</b> positions <b>200</b> mm from the front window. With spacing from left side according to the matrix below:							
180mm	480mm	780mm	1080mm	1380mm	1680mm	Fortuna 1800	
180mm	480mm	780mm	1080mm	1380mm	/	Fortuna 1500	
180mm	480mm	780mm	1080mm	/	/	Fortuna 1200	
115mm	355mm	595mm	835mm	/	/	Fortuna 900	
m/s	m/s	m/s	m/s	m/s	m/s		
m/s	m/s	m/s	m/s	m/s	m/s		
<b>Highest:</b>		m/s	<b>Lowest:</b>		m/s		
<b>Average height 350 mm:</b>		m/s	<b>Accept: 0,32 m/s ± 0,01 m/s</b>			<input type="checkbox"/> Pass	<input type="checkbox"/> Fail
<b>Average + 20%</b>			m/s	<b>Average - 20% - minimum accept 0,25 m/s</b>		m/s	
<b>Temperature outside cabinet:</b>			°C	<b>Temperature inside cabinet:</b>		°C	
<b>Fan speed setting H:</b>				<b>Fan speed setting L:</b>			
<b>Alarms setting H:</b>				<b>Alarms setting L:</b>			
<b>Date/signature:</b>							
<b>Thermo Anemometer ID-no:</b>							
<b>Calibration date:</b>							

<b>Sterile UDF Cabinet</b>	<b>Factory Test Report Fortuna 900,1200,1500,1800</b>	
----------------------------	---	---

Light test			
Adjust light to 100% on the control panel and wait 10 minutes before measuring. Measure the background light, and then place the light sensor on the table top and measure the light inside the cabinet. Accept: 800 Lux on the table top.			
<b>Background light:</b>	Lux		
<b>Light inside cabinet &gt; 800 Lux:</b>	Lux	<input type="checkbox"/> Pass	<input type="checkbox"/> Fail
<b>Date/signature:</b>			
<b>Lux-meter ID-no:</b>			

Air flow pattern test		
Demonstrate by use of smoke that the airflow is laminar, downwards without turbulences over the work surface.		
	<input type="checkbox"/> Pass	<input type="checkbox"/> Fail
<b>Date/signature:</b>		

High voltage test
-------------------

<b>Sterile UDF Cabinet</b>	<b>Factory Test Report Fortuna 900,1200,1500,1800</b>	
----------------------------	---	---

Test instruction: According to high voltage test instrument manual.				
Test	Acceptance	Result		
High voltage test:	2000 V	V	<input type="checkbox"/> Pass	<input type="checkbox"/> Fail
Date/signature:				
Test instrument ID-no:				
Calibration date:				

Electrical test				
Test instruction: According to Fulltest instrument manual.				
Test	Acceptance	Result		
Consumption with light on:		A	/	/
Consumption with light off:		A	/	/
Minimum leak resistance to earth:	2 MΩ	MΩ	<input type="checkbox"/> Pass	<input type="checkbox"/> Fail
Maximum resistance to Earth:	0,1 Ω	Ω	<input type="checkbox"/> Pass	<input type="checkbox"/> Fail
Maximum leak current:	3,5 mA	mA	<input type="checkbox"/> Pass	<input type="checkbox"/> Fail
Date/signature:				
Fulltest instrument ID-no:				
Calibration date:				







15 Annex 4 - Declaration of conformity – Fortuna



## Declaration of conformity

We declare under our responsibility, that the following product:

**Model:** Fortuna Clean Bench  
**Size:** 900, 1200, 1500, 1800

to which this declaration relates is in conformity with the following standard(s), directives or other normative document(s):

**In compliance with:**

**EN ISO 14644** - Cleanrooms and associated controlled environments

**EN 61010-1** - Safety requirements for electrical equipment for measurement, control and laboratory use - General requirements

**EN 61000-6-3, EN 61000-6-1** - Electromagnetic compatibility - Generic immunity/emission standard

**EN ISO 11201** – Acoustics – Noise emitted by machinery and equipment

**Following the provisions of:**

**2006/42/EC** - Machinery Directive, as amended

**2006/95/EC** - Low Voltage Directive, as amended

**2004/108/EC** - EMC Directive, as amended

**2011/65/EU** - RoHS Directive

**2012/19/EU** - WEEE Directive

Allerød, Oktober 2017



Rasmus Sørensen  
QA Manager  
LaboGene ApS, Bjarkesvej 5, 3450 Allerød, Denmark

27072017QA

