



6850 Series Control Module User Information

Contents

Introduction

- Important Information4
- Overview4
- Control Module elements5
- Navigating the screens8
- Configuring the instrument12
- To adjust the display contrast13
- Configuring the display and keyboard13
- Setting the time and date16
- To configure the RS-232 port16
- IP address settings17
- Plotting a signal20
- Plotting multiple signals23

Methods

- Designing a method26
- Saving the active method as a named method27
- Saving the active method as the SERVICE method29
- Restoring the default method29
- Using PC cards29
- Accessing methods in GC memory32

Flow and Pressure Control

- Hydrogen shutdown34
- Column shutdown34
- Electronic pneumatic control35
- Turning gas flows on and off35

- Interpreting flow and pressure displays .. 35
- Configuring the column36
- Column modes38
- Initial column flow or pressure40
- Flow or pressure programming41
- Auxiliary channels42
- Solving flow and pressure problems46

Automation

- Injector control49
- Sequence parameters53
- Controlling a sequence54
- Run Table55
- Clock Table59

Split/Splitless Inlet

- Using hydrogen61
- Options61
- Inlet Modes61
- Inlet and column62
- Inlet setup63
- Prep run64
- Setting the inlet mode65
- Split/Splitless terms65
- Pressure pulse modes66
- Split mode68
- Splitless mode70
- Gas saver73

Contents

Purged Packed Inlet

Using hydrogen	75
Inlet and column controls	75
Inlet Setup	76
Using a purged packed inlet	77

The Programmable Temperature Vaporization Inlet

Using hydrogen	79
Inlet modes	79
Inlet and column	80
Inlet setup	80
Setting the inlet mode	83
Heating the inlet	83
PTV terms	85
Pulsed modes	86
Split mode	93
Splitless mode	97
Solvent vent mode	103

The Cool On-Column Inlet

Inlet temperature	118
Operating the cool on-column inlet	120

Thermal Conductivity Detector

Using hydrogen	121
Operation conditions	121
TCD parameters	121
Makeup gas	124
Polarity	125
Signal selection	126

Analog output	128
Using the TCD	129

Flame Ionization Detector

Using hydrogen	130
Detector Operation Notes	130
Jets	131
Electrometer	131
Makeup gas	132
Signal selection	133
Analog output	135
Automatic reignition—Lit Offset	135
FID parameters	136
Using the FID	138

The Microcell Electron Capture Detector

Linearity	140
Detector gas	141
Temperature	141
Electrometer	141
Analog Output	141
Operating the Detector	142

Column Oven

Oven capabilities	144
Oven safety	144
Oven setup	145
Creating an isothermal run	146
Temperature programming	147
Column compensation	150

Contents

The Flame Photometric Detector (FPD)

Using hydrogen	153
General Information	153
Using lit offset	154
Igniting the flame	155
Using the electrometer	156
Signal selection	157
Selecting the makeup gas mode	159
Heater configuration	160
FPD Parameters	160
Using the FPD	161

Valves

Valve types	163
Configuring valves	164
Sample valves	164
Multi Valve with Sample Valve	166
Controlling valves manually	167
Setting the valve box temperature	168

Service Mode

The Service Screen	169
The Log Book	169
Diagnostics	170
Calibration	177
Maintenance	181
Update functions	185

Introduction

Important Information

© Agilent Technologies 1998, 1999, 2000, 2002, 2004

All Rights Reserved. Reproduction, adaptation, or translation without permission is prohibited, except as allowed under the copyright laws.

Vespel[®] is a registered trademark of E.I. duPont de Nemours Co., Inc.

Swagelok[®] is a registered trademark of Swagelok Company.

Part No. G2629-90329

First edition, March 2004

Replaces Part No. G2629-90327, G2629-90328, *Control Module User Information*

Printed in USA

Overview

The Control Module provides complete programming and control of the 6850 Gas Chromatograph (the GC), the 6850 automatic injector, and valves.

When connected to a 6850 GC, the Control Module can:

- Run analytical methods
- Create, edit, and transfer analytical methods between GCs via a PC memory card
- Set GC temperatures and flows and configure GC parts (columns, inlet, detector, etc.)
- Display real-time signals such as oven temperature or detector output
- Run diagnostic tests
- Provide context-sensitive information on messages, setpoints, needed actions, etc.
- Perform a number of other functions

Control Module elements

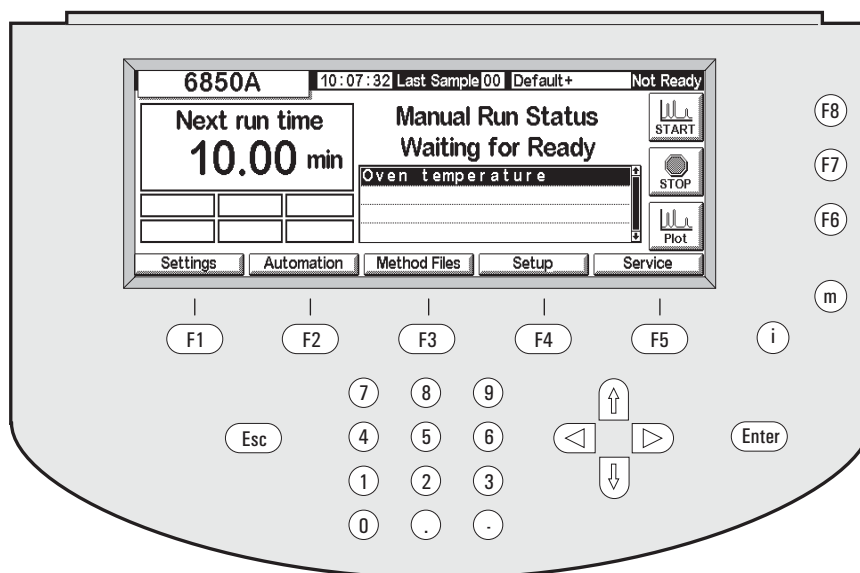

Figure 1. The Control Module

The Control Module consists of a display, a keyboard, and a connecting cable to a 6850 GC. A slot on the left side—not visible in the figure—can accommodate a PCMCIA flash memory card (called a PC card hereafter).

The Control Module is operated by entering instructions from the keyboard into a set of screens in the display. These instructions can then be stored as a named method.

Screens

Figure 1 shows a typical Status screen. This is the starting point for all screen based operations. The five labels along the bottom of this screen refer to the five keys (F1 through F5) just below them. The three labels on the right side refer to the three keys (F6 through F8) to their right. The key label functions change from screen to screen.

A complete list of screens appears in Table 2 on page 11.

Keyboard

The keyboard is used to navigate through the screens and enter instructions and data.

F1 to F5	Navigation keys. See the labels at the bottom of the screen.
F6 to F8	Action keys. See the labels on the right edge of the screen.
Esc(ape)	Cancel an action or return to the previous screen.
← →	Move the cursor in the display.
↑ ↓	Select settings, values, or alphanumeric characters.
m(enu)	Display additional dialogs.
i(nfo)	Context-sensitive help for the item presently selected; press twice to see the help index.
0 to 9	Enter numbers and letters.
.	Enter a decimal point.
-	Enter a minus sign.
Enter	Accept present input entry or action.

The **0 to 9** keys, plus the . and - keys, are also used to enter alphabetic characters. The special technique used is described later in this section.

Status screen

All operations begin at the Status screen, shown here. To return to the Status screen from any other screen, press **Esc** repeatedly.

Status

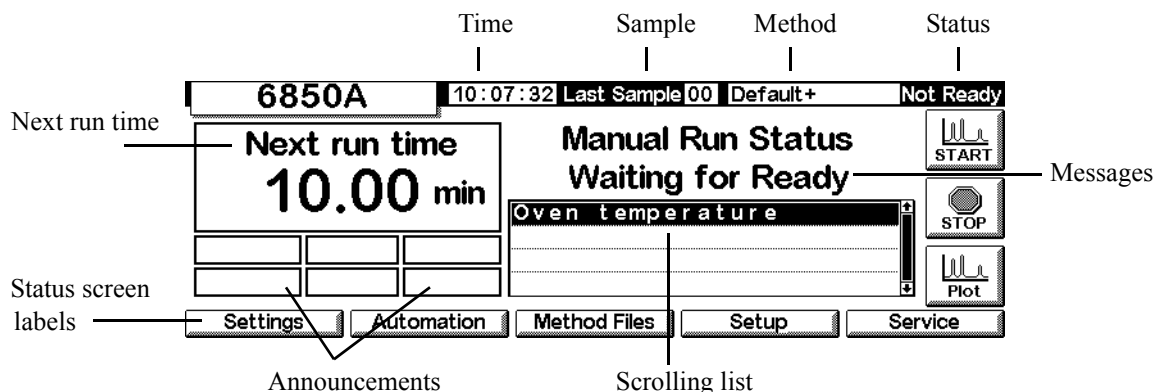

The Status screen elements are:

- *Time*—clock time on a 24-hour basis
- *Sample*—the last sample run or the one presently running
- *Method*—the name of the active method. If it has been modified since it was loaded, it is followed by a + sign.
- *Status*—the present condition of the GC
- *Announcements*—any current conditions that prevent the GC from starting a run or that may affect the results.

The Warning, Faults, Shutdown, and Method announcements advise you of potential problems. The Run Log announcement flashes to tell you to read the Run Log. The StrtLock announcement flashes when Start has been locked out by a Control Module or Agilent ChemStation or Agilent Cerity Networked Data System for Chemical QA/QC.

Keyboard Locked appears along the bottom of the Control Module screen if the keyboard is accessed while the StrtLock announcement is in effect.

- *Scrolling list*—shows problems with the GC or the active method. In this example, it tells you that the GC is Not Ready because the oven temperature has not stabilized.
- *Messages*—instrument condition. The messages describe the type of run or sequence the GC is preparing for, and whether or not it is ready.
- *Next run time*—the time the active method takes to complete a run

- *Status screen labels*—identify the function of the F1 through F5 keys below the display and the F6 through F8 keys on the right. See [Table 1](#).

Table 1. Status Screen Labels

Key	Screen label	Function
F1	Settings	Things you change frequently, such as oven temperature and hold times, inlet temperatures, and so on
F2	Automation	Valve and injector control, the clock and run tables
F3	Method Files	Creating and saving sets of control values
F4	Setup	Things you don't change very often, such as the maximum oven temperature, choice of pressure units, etc.
F5	Service	Log files, tests, temperature and pressure calibrations, etc.
F6	Plot	Shows a developing signal in real time on the display
F7	Stop	Stops a run or sequence
F8	Start	Starts a run or sequence

Navigating the screens

This example illustrates the use of the Control Module to set up the column so that the instrument can convert flows to pressures and the reverse.

Example: Column Setup

1. Begin at the Status screen. If you are at any other screen, press **Esc** repeatedly until this screen appears.

Status

The screenshot shows the Status screen with the following elements:

- Top bar: 6850A | 10:07:32 | Last Sample 00 | Default+ | Not Ready
- Main display:
 - Left: Next run time 10.00 min
 - Right: Manual Run Status Waiting for Ready
 - Below status: Oven temperature (selected)
- Right side icons: START (F8), STOP (F7), Plot (F6)
- Bottom function keys: Settings (F1), Automation (F2), Method Files (F3), Setup (F4), Service (F5)

- Press Setup (F4) to display the next screen. In this document, most screens are preceded by the route (in this case, Status/Setup) to follow to get to them from the Status screen.

Status / Setup

- Press Column Setup to get to the next screen. The second version shown below appears with Auxiliary EPC GCs. The first screen appears with all others.

Status / Setup / Column Setup

- Check that the column source and outlet connections are correct. If not, use the ← and → keys to get to the correct set of choices and the ↑ and ↓ keys for the specific choice. Press Enter.

- The ? mark and the message in the center indicates the column is not configured. To correct this, press More (F6) to display the popup menu.

Status / Setup / Column Setup / More

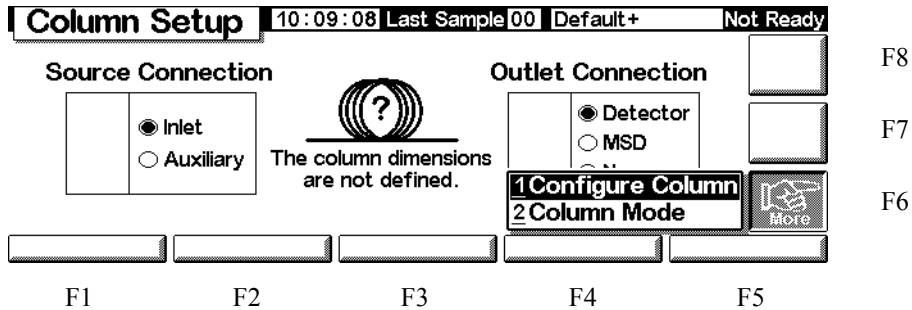

- Use ↑ and ↓ to select Configure Column and press Enter, or press the number 1 key.

Status / Setup / Column Setup / More / Configure Column / Enter

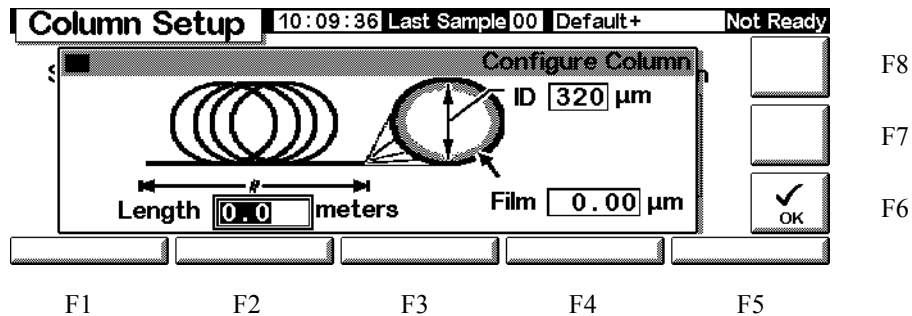

- Use ← and → to get to the three fields, type the numeric values using the units shown on the screen, and press OK (F6). This accepts the values and returns to the previous screen.

Status / Setup / Column Setup

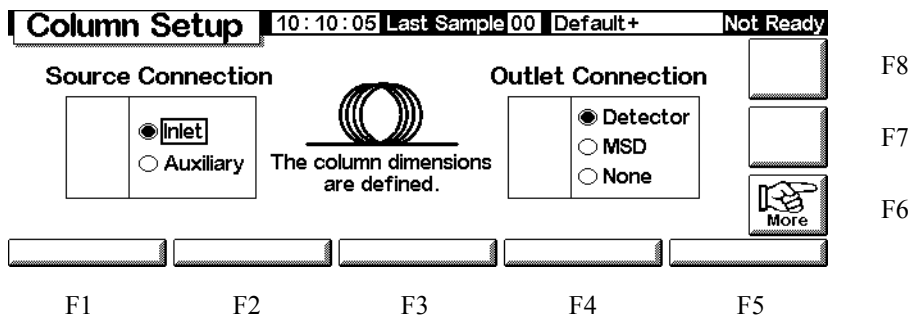

- Notice that the ? mark is gone because the column is now configured.

To get back to where you started, press Esc repeatedly to move up through the screens. In the rest of this document, we will show the screens without the F-number labels.

Table 2. Control Module Screens

<u>F1 Settings</u>				
F1 Inlet	F2 Oven	F3 Column	F4 Detector	F5 Auxiliary
Temperature, ramps, temp. mode, pressure, flows, ramps, modes (inlet*, pulse*, gas saver*, pulse/split*, solvent vent*), carrier gas*, units*, coolant info	Temperature, programs	Flow and pressure program, column mode, configuration	Temperature, flows, signal, outputs, gas type	Temperature and pressure programs, Aux EPC settings
<u>F2 Automation (sequence type, samples used, sequence repeat, sequence controls)</u>				
F1 Injector	F2 Valves		F4 Clock Table	F5 Run Table
Volume, pumps, washes, depth, dwell times, viscosity, slow plunger	Toggle valves		Add & delete events	Add & delete events
<u>F3 Method Files (view active, save active, save service, revert to default)</u>				
		F3 Save Listing	F4 PC Card	F5 GC Methods
			Save, load & delete	Load & delete
<u>F4 Setup (column compensation)</u>				
F1 Inlet Setup	F2 Oven Setup	F3 Column Setup	F4 Automation Setup	F5 Configure
Carrier, pressure units, vacuum correct, cryo control	Equilibrium time, maximum temperature, cryo control	Source & outlet connections, configure, mode	Injector, sample valve, multi valve, auto prep run	Oven, serial #, mfg date, clock, serial & LAN comm, local UI, display, detector type, valve 1 & 2, aux temp & pressure, inj. model and capacity, column dimensions
<u>F5 Service (run log, start service, exit service)</u>				
F1 Log Book	F2 Diagnostics	F3 Calibration	F4 Maintenance	F5 Update

View/Save log book	Inlet, detector, keyboard	Factory settings for oven, inlet, column, detector, Aux EPC	Service limits, early maintenance feedback	Update GC, Injector, Control Module firmware
<u>F6 Plot signals</u>				
<u>F7, F8 Start & Stop Runs</u>				

* Split/Splitless and PTV inlets only

Configuring the instrument

The instrument will need to be configured

- before the first use
- whenever changing or adding new hardware

Configuring the instrument sets global parameters, such as date and time, and also tells the instrument about the devices installed in it so that the GC can control them properly.

Note that configuration settings directly affect your methods. Unconfigured devices may be unavailable on the display, or may have no settable values. Also, these settings control the execution of certain tasks, for example, charging the sample loop of a gas sampling valve.

Before using the GC for the first time, configure the following items/features:

- display contrast (see [To adjust the display contrast](#) on page 14.)
- display and keyboard (see [Configuring the display and keyboard](#) on page 14.)
- time and date (see [Setting the time and date](#) on page 17.)
- IP address settings (see [IP address settings](#) on page 18.)
- communication settings (see [To configure the RS-232 port](#) on page 17 and [IP address settings](#) on page 18)
- column (see [Navigating the screens](#) on page 8 and [Configuring the column](#) on page 38.)
- automation parameters, such as injector information (see [Automation](#) on page 52.)
- inlet (see the chapter for the appropriate inlet type.)
- detector (see the chapter for the appropriate detector type.)
- auto prep run (see [Prep run](#) on page 68.)

- oven (see [Oven setup](#) on page 149.)
- valves (see [Configuring valves](#) on page 168.)

View the current configuration

You can display a list of items describing the GC's installed components. The list describes the GC, listing such items as the serial number and the injector mode (if installed). Following is an example of this screen. Press ↑ and ↓ to scroll up and down in the list.

Status / Setup / Configure

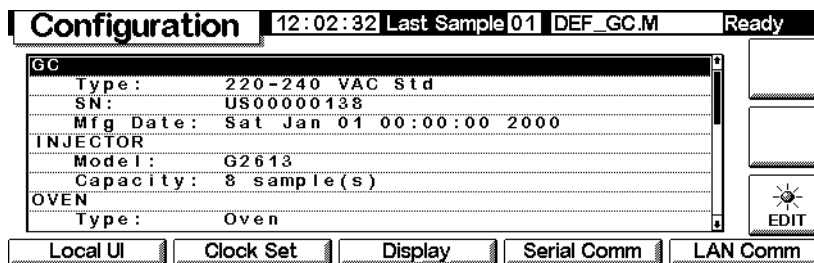

To adjust the display contrast

1. Display this screen.

Status / Setup / Configure / Display

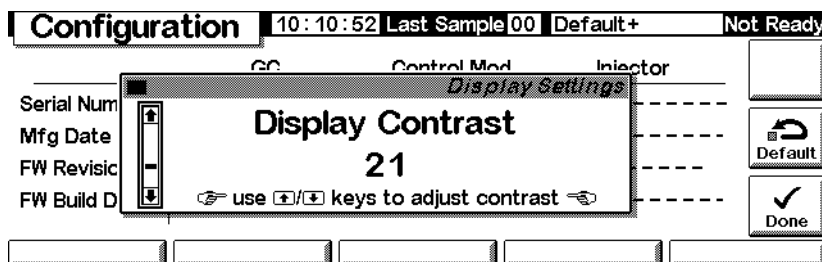

2. Use the ↑ and ↓ keys to adjust the screen contrast. Press Done when satisfied.

Configuring the display and keyboard

The Control Module can define the functions available at the GC keyboard and display. This is useful when, for example, a GC is to be used as a dedicated analyzer or operated by a remote ChemStation or Certity Chemical.

To define the GC keyboard and display functions:

1. Display this screen.

Status / Setup / Configure / Local UI

- *Oven Temp, Message Line, Inlet Pressure, Column Flow, Signal, and Run Time* are display-only features—changing the values requires a Control Module or a ChemStation
 - *Service Mode*—Allows the SERVICE method to be loaded from the keyboard (see [Service Mode](#) on page 173)
 - *Stored Methods*—Places the list of methods stored in the GC in the scrolling display so they can be selected and loaded from the keyboard
 - *Run Time Mode*—Controls whether the Run Time, if displayed, counts up (time elapsed since start) or down (time to end of run). This choice does not affect the Run Table.
2. Select the items you want displayed on the GC display, the actions you want to be able to perform at the GC keyboard, and, if Run Time is selected, the Run Time Mode.
 3. Press Beeps to display the next screen.

Status / Setup / Configure / Local UI / Beeps

4. Select the beep behaviors you want.

5. Press **ESC** to return to the **Local** UI screen, then press **Locks** to display the next screen.

Status / Setup / Configure / Local UI / Locks

Local Locks		10:12:25	Last Sample 00	Default+	Not Ready
<input type="checkbox"/> Lock Local Keyboard	Host Lock:	<input type="checkbox"/> Off			
<input type="checkbox"/> Lock Local Start Key	Sequence Lock:	<input type="checkbox"/> Off			
<input type="checkbox"/> Lock Remote Start	Clock Table Lock:	<input type="checkbox"/> Off			
	Clock Table Exec Lock:	<input type="checkbox"/> Off			
	Method & Sequence & Clock Table Lock:	<input type="checkbox"/> Off			

- *Lock Local Keyboard*—deactivates all parameter changes from the Control Module
- *Lock Local Start Key*—deactivates the **Start** key on the GC keyboard
- *Lock Remote Start*—deactivates the **Start** function of the REMOTE connector on the back of the GC. You can still start a run using a Control Module.
- *Host Lock*—a reported value. **On** means that a ChemStation or other computer is controlling the GC, and you cannot change setpoints from the Control Module.
- *Sequence Lock*—locks out sequence execution from the GC
- *Clock Table Lock*—locks out clock table access
- *Clock Table Exec Lock*—locks out execution of clock table events
- *Method & Sequence & Clock Table Lock*—locks out method loading from the GC keyboard or the Control Module, plus the Sequence and Clock Table locks

Setting the time and date

The GC has an internal clock to use the time and date for tasks such as logging methods and errors. To set the time and date:

1. Display this screen

Status / Setup / Configure / Clock Set

Configuration		10:11:33	Last Sample 00	Default+	Not Ready
Ser					
Mfg					
FW					
FW					
Time		Hour	Min	Sec	
		<input type="text" value="10"/>	<input type="text" value="11"/>	<input type="text" value="33"/>	
Date		Day	Month	Year	
		<input type="text" value="11"/>	<input type="text" value="11"/>	<input type="text" value="2002"/>	
					<input checked="" type="checkbox"/> Done

2. Set the date and time and press Done.

To configure the RS-232 port

This refers to the connector labeled RS-232 on the back of the GC. It does not affect Control Module/GC communications.

Normally, the 6850 will be configured for proper communications at the factory. However, if you need to check or alter the communications settings, do so as follows:

1. Display this screen.

Status / Setup / Configure / Serial Comm

Host Serial		12:55:13	Last Sample 00	SERVICE+	Not Ready
Baud Rate	Parity	Handshake	Data	Stop	Term
<input type="radio"/> 300	<input type="radio"/> odd	<input checked="" type="radio"/> none	<input type="radio"/> 7	<input checked="" type="radio"/> 1	<input checked="" type="radio"/> LF
<input type="radio"/> 1200	<input type="radio"/> even	<input type="radio"/> xon-xoff	<input checked="" type="radio"/> 8	<input type="radio"/> 1.5	<input type="radio"/> CR
<input type="radio"/> 2400	<input checked="" type="radio"/> none	<input type="radio"/> cts/rts		<input type="radio"/> 2	
<input type="radio"/> 4800	<input type="radio"/> mark				
<input checked="" type="radio"/> 9600	<input type="radio"/> space				
<input type="radio"/> 19200					
<input type="radio"/> 28800					
<input type="radio"/> 38400					
<input type="radio"/> 57600					

2. Adjust the controls to meet the needs of the external device. Press Esc when finished.
3. Set the date and time. The clock resets when you press Done.

IP address settings

The method of setting the IP address depends on the type of LAN card you have installed in your GC.

To view the current settings, display this screen.

Status / Setup / Configure / LAN Comm

LAN Setup		03:00:05	Last Sample 00	Default	Not Ready
LAN Card Settings					
IP Address	130 . 30 . 255 . 236	Timeout 99 seconds			
Subnet Mask	255 . 255 . 248 . 0				
Default Gateway	130 . 30 . 248 . 1				
Control Mode	Use BootP to get address				
<input type="button" value="Set LAN"/> <input type="button" value=""/> <input type="button" value=""/> <input type="button" value=""/> <input type="button" value=""/>					

If installed, the current LAN card settings are shown for reference. The IP address, subnet mask, default gateway, and timeout values are set when the LAN card/GC is installed. The control modes are explained below.

Control modes

The control mode displayed on the LAN Setup screen indicates the current method of obtaining LAN configuration settings. The available control modes depend on the LAN card installed (see [Table 3](#)). For information on how to identify which LAN card is installed in your GC, see

[View the current configuration](#) on page 14.

Table 3. Available Control Modes

LAN card	Available control modes	Enter settings
J2552B	BootP	N/A
J4100A	BootP, Locally entered settings	At GC front panel
Lantronics	DHCP, Locally entered settings	At GC front panel, Control Module

- If a J2552B or J4100A LAN card is installed, the message “Supports BootP Control Mode Only” is displayed. While it is possible to set the LAN address from the Control Module, this practice is *not recommended*. The resulting connection will be very slow.
- *Use BootP/DHCP to get address:* Your GC is set to receive LAN addressing

from the BootP program or Windows NT[®] DHCP.

- *Use locally entered settings:* Your GC is set to use IP address, subnet mask, and gateway values that you will provide via the Control Module or GC front panel.

To adjust the settings, display this screen:

Status / Setup / Configure / LAN Comm / Set IP

The screenshot shows the 'LAN Setup' screen with a title bar containing 'LAN Setup', '02:59:05', 'Last Sample 00', 'Default', and 'Not Ready'. The main area is titled 'LAN Settings' and contains the following fields:

IP A	<input type="radio"/> Local	IP Address	130	30	255	236
Sub	<input checked="" type="radio"/> BootP / DHCP	Subnet	255	255	248	0
Def		Gateway	130	30	248	1
Cor						

At the bottom right of the 'LAN Settings' window is a 'Done' button with a checkmark icon.

Automatically-assigned address settings

1. Select **BootP/DHCP** to use the BootP program or DHCP to set the GC LAN card configuration. The GC will automatically use the appropriate method.
2. Press **Done**. The new settings will not take effect until the GC is restarted. To restart now, select **Yes** when the following window appears:

The screenshot shows a confirmation dialog box with a title bar 'LAN Setup' and a status bar '02:59:05', 'Last Sample 00', 'Default', and 'Not Ready'. The dialog box contains the following text:

! The new lan settings have been loaded.
Changes will take effect after the GC is restarted.
Do you want to restart the GC now?

At the bottom of the dialog box are two buttons: 'Yes' (with a checkmark icon) and 'No' (with a circle and slash icon). A 'Done' button is visible in the bottom right corner of the background window.

Specific IP address settings

The Control Module can be used to adjust LAN settings for 6850 GCs that use the Lantronics LAN card. See [View the current configuration](#) on page 14 for information on how to identify which LAN card is installed in your GC.

1. Display this screen.

Status / Setup / Configure / LAN Comm / Set LAN

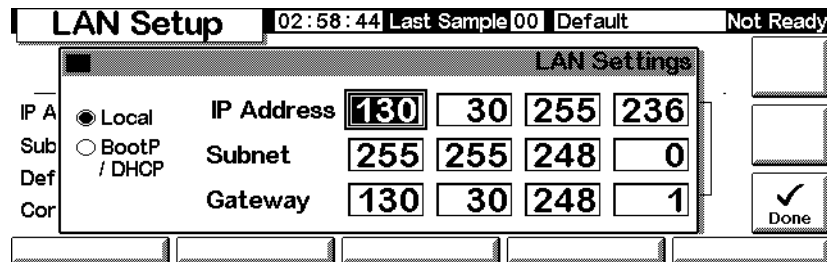

2. Select **Local** to use IP address, subnet, and gateway settings that you will provide.
3. Use ← and → to move from field to field and use the number keys to adjust the values.
4. Make sure the settings are correct and press **Done**. The new settings will not take effect until the GC is restarted. To restart now, select **Yes** when the following window appears:

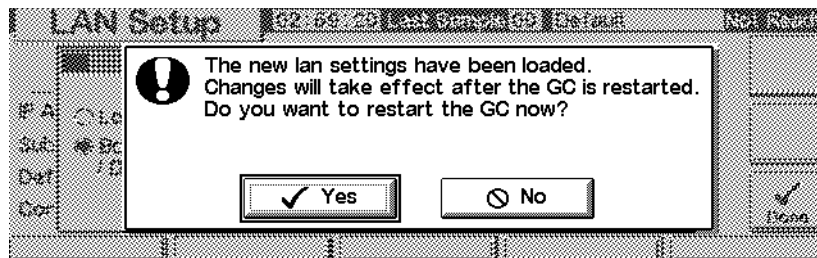

Plotting a signal

The Control Module screen can display up to three real-time plots at the same time. Plotting is best explained with examples.

To plot one signal

1. Display this screen.

Status / Plot

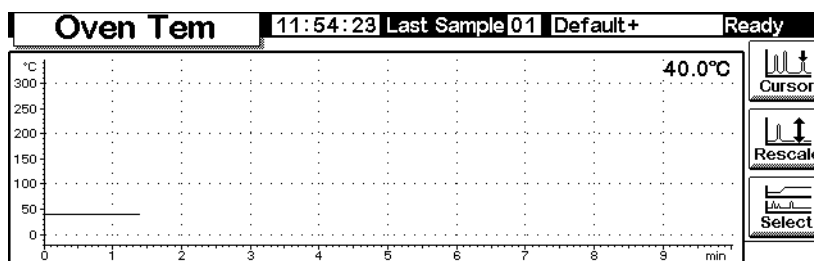

2. The screen is presently plotting Oven Temperature. Press **Select** to see a list of the available signals.

Status / Plot / Select

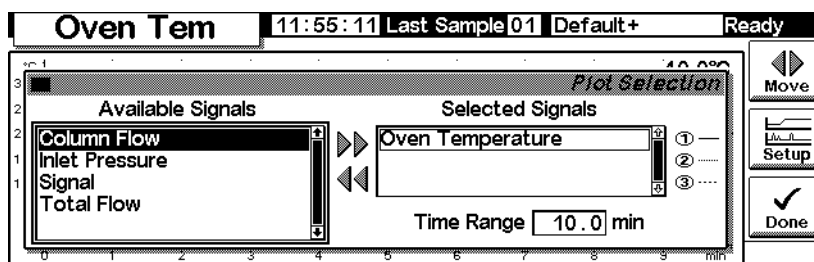

Signal, in the **Available Signals** list, is the signal selected on the detector screen.

It may be any of the following:

- Detector
- Column Comp
- Detector - Col Comp
- Test Chromatogram
- Other

See the detector section for more details.

3. To move a signal from one list to the other, select it and press Move. Although you can have up to three Selected Signals, we will consider the one signal case first.
4. For this example, we assume that you moved Oven Temperature back to Available Signals and move Signal to Selected Signals.
5. After making these moves, the Selection screen reads as follows:

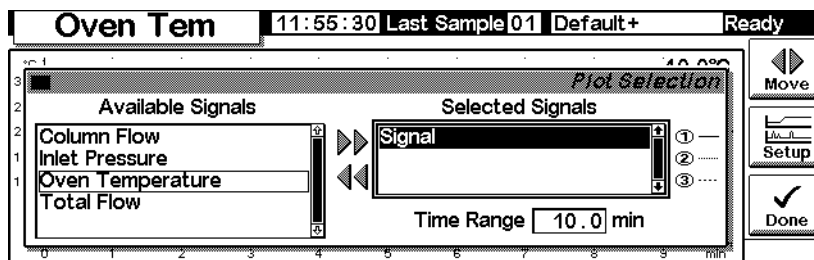

6. Enter a Time Range. This is the width, in minutes, of the plot. If the run lasts longer than this, the plot scrolls off the screen to the left.
7. At this time, you can press Setup to set the vertical scale (Y Range). This is not absolutely necessary because you can always rescale the plot later.

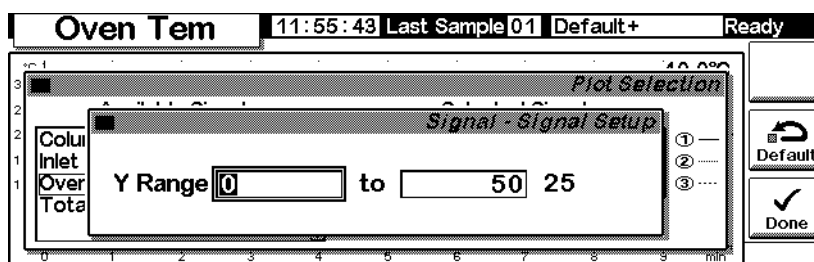

8. Press Done to return to the signal selection screen, then press Done again to see the plot. If you did not set a Y Range, and possibly even if you did but set it too large, the plot may look like this.

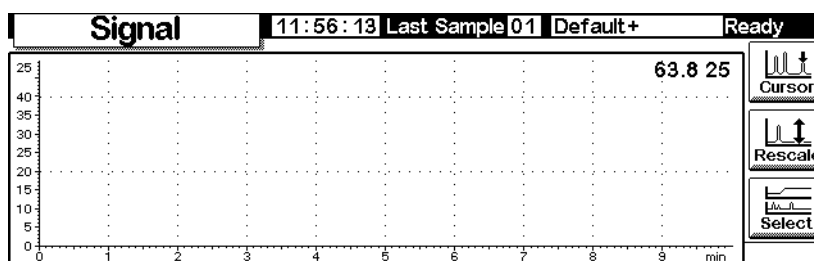

9. Press Rescale. This changes the Y range so that the plot fills the window.

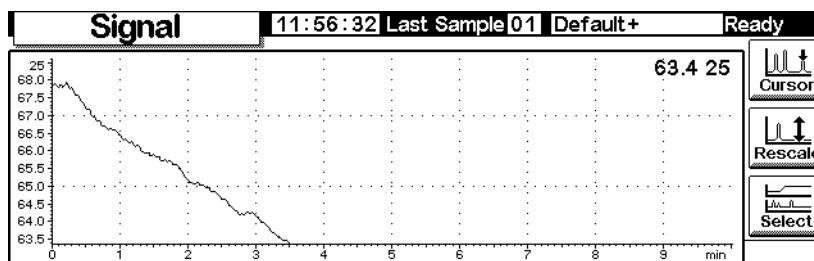

10. To refine the scaling, use ← and → to adjust the horizontal scale and ↑ and ↓ to adjust the vertical scale. In this example, the vertical scale is too sensitive and needs adjusting.

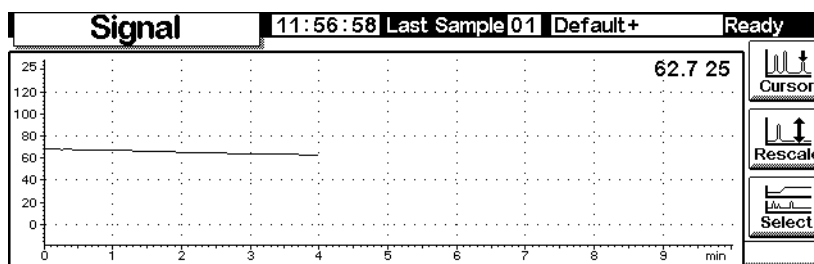

11. Inject a sample—air was used for this example—and press Start. A vertical line marks the start of the run.

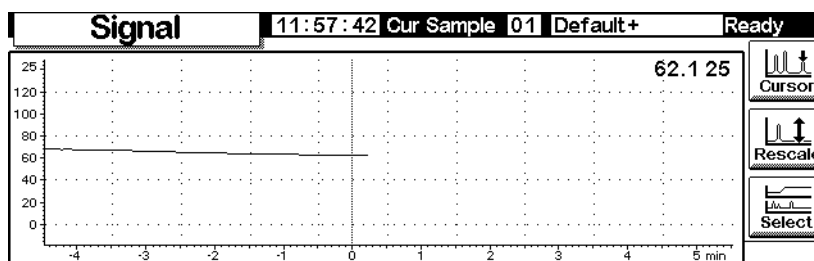

12. When the peak appears, it goes off scale. Wait for the trailing edge to appear, then press **Rescale** to bring the top of the peak on scale. Press \downarrow once.

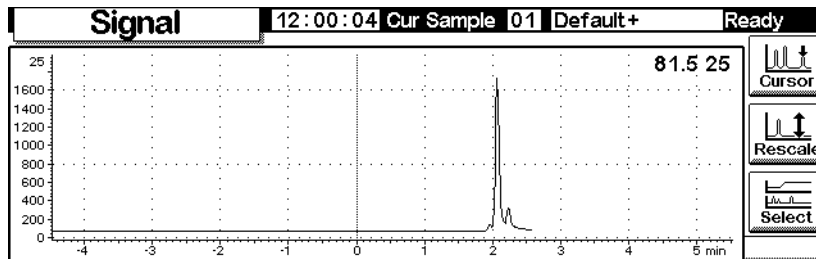

13. To explore the plot in detail, press **Cursor**. An arrow appears on the screen, and the values of time and Signal appear in the top right corner of the screen.
Use the \leftarrow and \rightarrow keys to move the cursor. The next screen shows the retention time and peak height of the smaller peak.

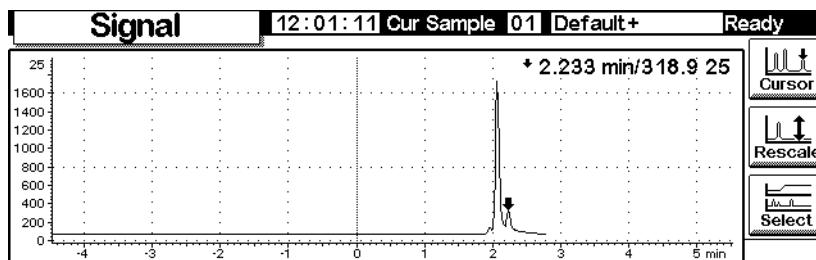

14. To remove the cursor, press **Cursor** again.

Plotting multiple signals

This is the rescaled plot of the detector signal described on the preceding pages. We will add a plot of the oven temperature.

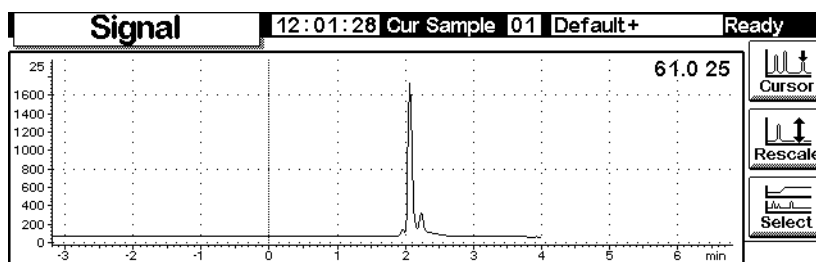

1. Display this screen.

Status / Plot

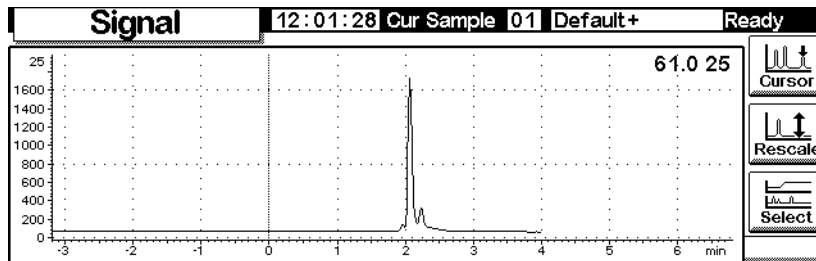

2. Press Select to display the list of signals. Select Oven Temperature and press Move. This screen appears:

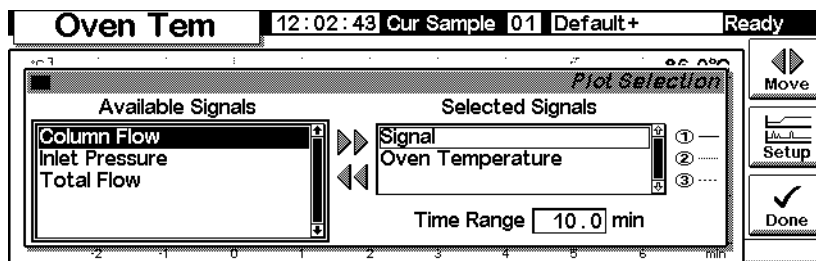

3. Use the \uparrow and \downarrow keys, or press 2, to highlight Oven Temperature. Press Setup to set the Y Range for this signal. We suggest a range of 0°C to 150°C.
4. Press Done to return to Plot selection, then press Done again to show both plots.

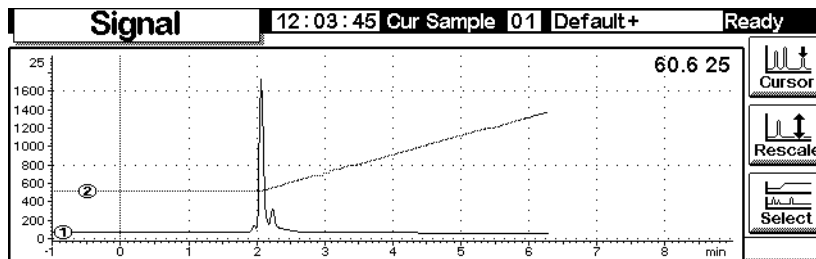

The two plots are superimposed but have independent Y scales. Note the small ① and ② that identify the two plots. Use the 1 and 2 keys to select these plots. As you do so, the Y scale changes to that of the selected plot.

For example, to rescale the Oven Temperature plot, press 2 to select the plot, then press `Rescale`. Similarly, the `←`, `→`, `↑`, and `↓` keys work independently for the two plots to adjust their scaling.

Methods

There is always an active method in the GC memory. It is the set of control values that are presently operating the GC, including Run Table events and automatic injector controls.

The active method changes as you adjust conditions to perform your analysis. To save the changes and make a permanent method:

1. Modify the active method to suit your needs.
2. Name the method and save it in GC memory. Five named methods and a method named `SERVICE` can be stored.

This section describes how to save the active method, either as a named method or as the `SERVICE` method.

We also describe the use of a PC Card to copy named methods from the GC and to download them to the GC.

The *content* of the method—the details of all the things that can be controlled—is described in the sections following this one.

Designing a method

A method is a set of control values that determines what the GC does. Methods are created using a Control Module or ChemStation and are executed by the GC.

- The content of many screens depends on what hardware is present. While the GC can sense many of its components, some information (such as what carrier gas is in use) must be entered by you. Always configure (define) instrument elements before trying to use them.
- When setting up a method, configure the carrier gas first, then the column, and finally the inlet. Detectors can be set up at any time.
- The `i` key on the Control Module provides information about the current screen. Press it again to access the information system index.

Saving the active method as a named method

To name and save the active method:

1. Display this screen.

Status / Method Files

The screenshot shows the 'Method Files' screen with the following details:

- Header: Method Files | 10:37:38 Last Sample 00 | Default+ | Not Ready
- Method Name: 6850 Series Gas Chromatograph
- Date/Time: 23 Oct 98 10:09
- Default
- OVEN parameters:
 - Temp 50 deg C
 - Initial time 10.00 min
 - Maximum temp 350 deg C
 - Equip time 0.00 min
- Buttons: Save, Service, Default
- Bottom bar: Save Listing, PC Card, GC Methods

2. The screen displays the beginning of the active method. Use the ↑ and ↓ keys to examine it and verify that all values are correct.
3. Press Save to display this screen.

Status / Method Files / Save

The screenshot shows the 'Save Current Method As' dialog box with the following details:

- Header: Method Files | 10:37:56 Last Sample 00 | Default+ | Not Ready
- Title: Save Current Method As
- Method Name: [Empty text field]
- GC Selection:
 - GC
 - 1
 - 2
 - 3
 - 4
 - 5
- Buttons: OK

4. The Control Module keys have both labeled and hidden values (see [Table 4](#)). The hidden values apply *only* for entering text in an alphanumeric field, such as the Method Name field on this screen.
5. Move the cursor to the left end of the name field. Use the keyboard to enter a Method Name.
 - a. Move the cursor using the ← and → keys.
 - b. Press a labeled key multiple times to reach the hidden values. If you go too far, keep pressing because the values loop.
 - c. Do *not* add an extension to the method name.

Table 4. Key Labels and Hidden Characters

Key label	Hidden characters
1	A B C
2	D E F
3	G H I
4	J K L
5	M N O
6	P Q R
7	S T U
8	V W X
9	Y Z _
0	none
.	, ; :
-	+ * /

6. Press OK when you finish to save the method in GC long-term memory. See [Table 5](#).

Table 5. Saved Method Content

Item	Saved?
Oven controls	yes
Injector controls	yes
Injector/valve sample list	not saved
Inlet	yes
Column	yes
Detector	yes
Signal	yes
Column compensation	yes
Aux 1	yes
Run Table	yes
Sample valve	yes
Multi valve	yes
Sequence sample list	not saved

Clock table not saved

Saving the active method as the SERVICE method

1. Display the method using *Status / Method Files*.
 2. Press *Service* to save the active method as the SERVICE method. This replaces the existing SERVICE method with the contents of the active method.
-

Restoring the default method

The default method, loaded at the factory, contains parameters that are a reasonable starting point for many analyses. This method can be edited to better meet your needs.

To restore the original factory settings, press *Default*. This screen appears.

Status / Method Files / Default

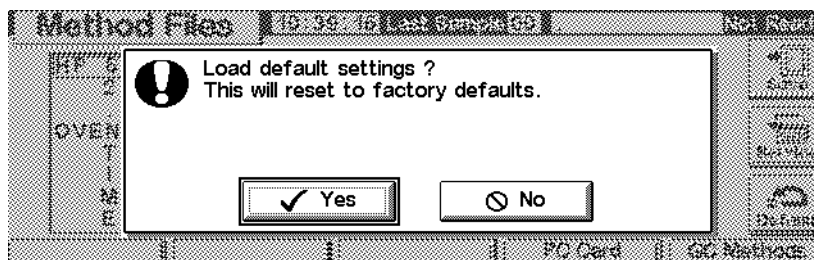

- Press *Yes* to load the default method. This becomes the new active method. The previous active method is lost unless it has been saved.
 - Press *No* to cancel the load operation. The active method remains intact.
-

Using PC cards

Methods can be stored in the GC or on a PC card in the Control Module. By using multiple PC cards, an extensive library of methods can be stored for any GC. You can also save a listing for each method. A listing is a text file of the method's setpoints exactly as they appear on the control module.

To use a PC card, insert it into the Control Module *before* connecting to the GC. If you would like use another PC card, you must first disconnect the Control Module before changing cards.

PC cards are available in various memory capacities at most computer stores. A PC

card is not provided with the Control Module.

To copy a method from the GC to a PC card

1. Display this screen.

Status / Method Files / PC Card

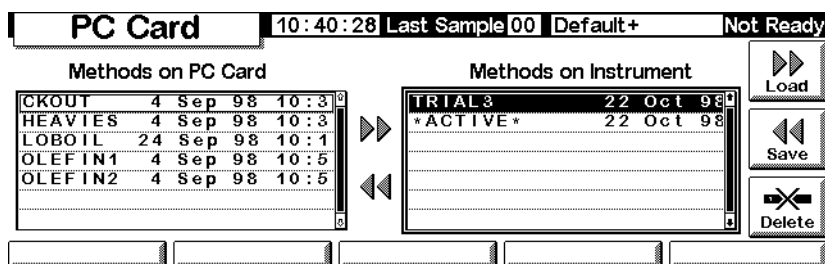

2. Select a method on the right-hand list.
3. Press Save to copy it to the PC card.

To copy a method from a PC card to a GC

Methods stored on a PC card can be downloaded to the original or a different GC.

1. Display this screen.

Status / Method Files / PC Card

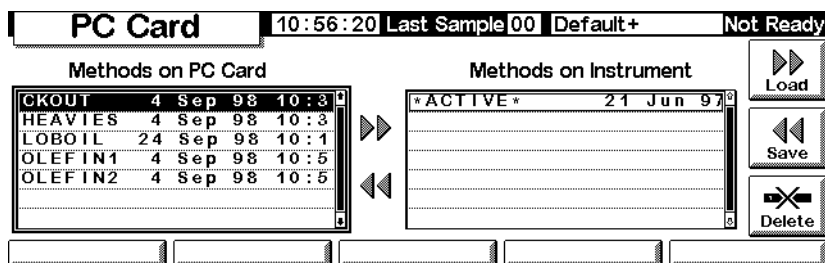

2. Select a method name on the left-hand list.
3. Press Load. The selected method becomes the *active method* on the GC.
4. Execute Save on the Status / Method Files screen and supply a name to save the method to the GC long-term memory.

To delete methods from a PC card

1. Display this screen.

Status / Method Files / PC Card

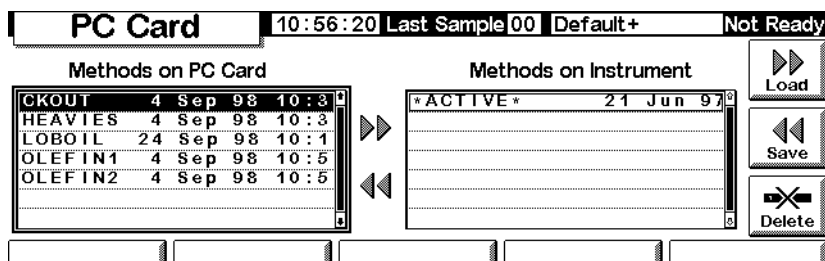

2. Select a method in the left list.
3. Press Delete. A popup menu appears.

Status / Method Files / PC Card

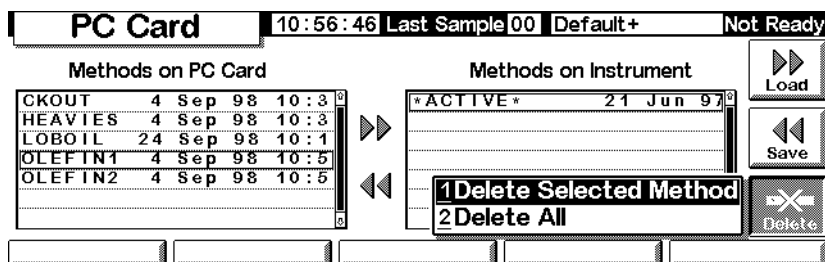

4. Select the deletion mode and press Enter.
5. A confirmation screen will be displayed. Select Yes or No and press Enter.

To save a method listing to a PC card

If you can access data on a PC card, (using a portable computer, for example), saving a method listing conveniently lists all method parameters and settings in text file format.

Status / Method Files

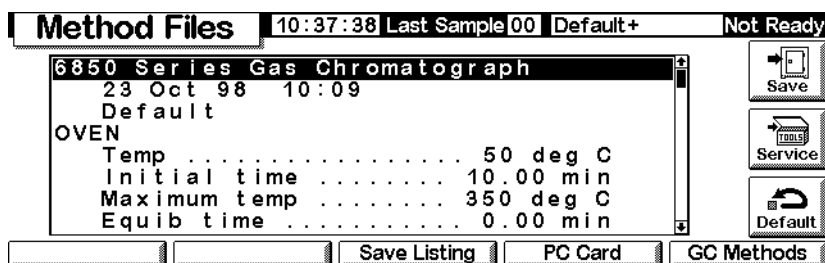

Press **Save Listing**. A text file called *methodname.lst* is saved onto the Method Files screen. Note that the Control Module automatically overwrites any previous version of the listing.

Accessing methods in GC memory

To view the list of methods stored in the GC

Display this screen.

Status / Method Files / GC Methods

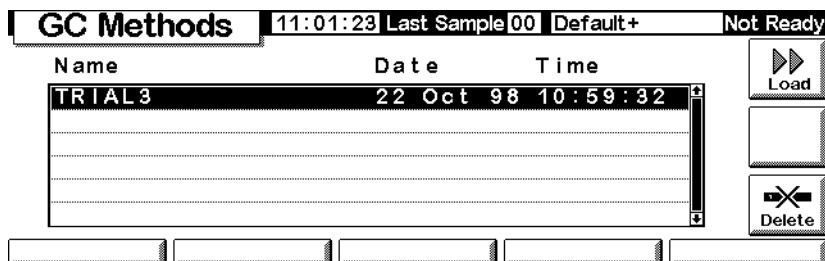

To load a stored method

Select the desired method, then press **Load**. The selected method becomes the active method.

To delete method files from GC long-term storage

1. Select a method and press **Delete**. A popup menu appears.

Status / Method Files / GC Methods / Delete

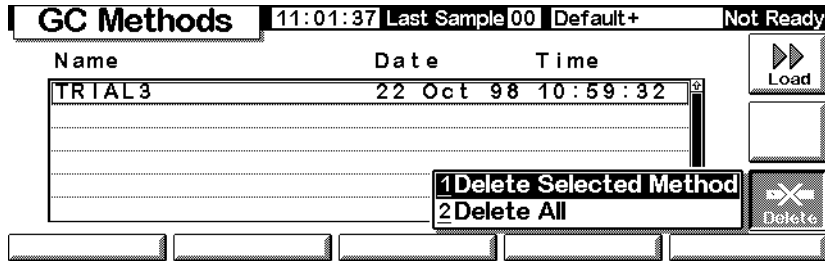

2. Select the deletion mode and press **Enter**.
3. A confirmation screen appears. Select **Yes** or **No** and press **Enter**.

Flow and Pressure Control

Hydrogen shutdown

Hydrogen gas may be used as a carrier or as fuel for some detectors.

Warning

When using hydrogen (H₂) as a carrier gas or fuel gas, be aware that hydrogen can flow into the oven and create an explosion hazard. Be sure that the hydrogen supply is off until all connections are made and ensure that the inlet and detector column fittings are either connected to a column or capped at all times when hydrogen gas is supplied to the instrument.

Hydrogen is flammable. Leaks, when confined in an enclosed space, may create a fire or explosion hazard. In any application using hydrogen, leak test all connections, lines, and valves before operating the instrument. Always turn off the hydrogen supply at its source before working on the instrument.

The GC monitors flow rates and pressures. If a stream shuts down because it is unable to reach its flow or pressure setpoint and if that stream is configured to use hydrogen, the GC assumes that a leak has occurred and causes a *hydrogen safety shutdown*. The effects are:

- The carrier supply valve to the inlet closes
- The split valve in the split/splitless inlet opens
- The oven heater turns off. The oven flaps open fully.
- The inlet, detector, and auxiliary heated zones are turned off.

To recover from this state, fix the cause of the shutdown (tank valve closed, serious leak, etc.). Turn the instrument off, then back on.

Column shutdown

If the carrier gas source shuts down, the oven heater turns off to avoid column damage from heat without carrier gas. The oven flaps open halfway.

To recover from this state, fix the cause of the shutdown (tank valve closed, serious leak, etc.). Turn the oven and the offending inlet or auxiliary channel back on.

Electronic pneumatic control

The GC electronically controls all gas flows and pressures. This provides:

- Flow and/or pressure control for the inlet, including flow or pressure programming for the carrier gas through the column
- Flow control via pressure regulation across fixed restrictors for all detector gases
- Pressure control for three auxiliary channels via pressure regulation across fixed restrictors
- A gas saver mode to reduce carrier gas consumption between sample runs (split/splitless inlet)
- Direct entry of split ratios, provided the column is configured (split/splitless inlet)

Enter setpoints in the inlet, detector, or auxiliary screens.

Turning gas flows on and off

All gas flows have an OFF setting so they can be turned on or off without disturbing the flow or pressure setpoints. To turn a flow off, select the setpoint and press either the ↑ or ↓ key.

The valves in the gas control modules are designed for gas metering rather than ON/OFF operation. When this type of valve is driven to the OFF state, there may still be a small flow, as much as 0.2 mL/min, through it.

Interpreting flow and pressure displays

The GC measures atmospheric pressure and temperature to eliminate local conditions as causes of retention time variability.

All flow and pressure displays are corrected to a defined set of conditions. These conditions, which we call Normal Temperature and Pressure (NTP), are 25°C and 1 atmosphere pressure. Similarly, setpoints are adjusted for the local conditions.

Thus a flow displayed on the instrument and the flow measured with a bubble meter may not agree, because the bubble meter readings are local conditions rather than NTP conditions. However, retention times become independent of the local environment.

To convert bubble meter flow rate measurements to NTP (25°C and 1 atmosphere), you must know the local atmospheric pressure and the bubble meter temperature at the time of measurement.

The conversion is:

$$\text{Flow rate at NTP} = \frac{\text{Flow rate}_{\text{local}} \times 298 \times \text{Pressure}_{\text{local}}}{\text{Temperature}_{\text{local}}}$$

where:

Flow rate at NTP	is the flow rate in mL/min corrected to Normal Temperature (25°) and Pressure (1 atmosphere)
Flow rate_{local}	is the flow rate in mL/min measured by the bubble meter
Temperature_{local}	is the temperature of the bubble meter at the time of measurement. This number is in Kelvin (Kelvin = Celsius + 273).
Pressure_{local}	is the local atmospheric pressure at the time of measurement. This number is in atmospheres (1 atm = 1.01325 bars = 760 Torr = 760 mm Hg (at 0°C) = 101.325 kPa = 14.7 psi).

Some electronic flow meters are calibrated for temperatures other than 25°C or pressures other than 1 atm. These will give readings that do not agree with the displays unless they are corrected to NTP.

Configuring the column

To define (configure) a capillary column, enter its length, diameter, and film thickness. With this information, the GC can calculate the flow through the column.

This has great advantages when using capillary columns with a split/splitless inlet, because it becomes possible to:

- Enter split ratios directly and let the instrument calculate and set the appropriate flow rates
- Enter flow rate or head pressure. The instrument calculates the pressure needed to achieve the flow rate, sets that, and reports both values.

- Perform splitless injections with no need to measure gas flows
- Choose any of the four column modes (see [Column modes](#) on page 40). If the column is not defined, your choices are limited.

To configure the column

1. Display this screen.

Status / Settings / Column

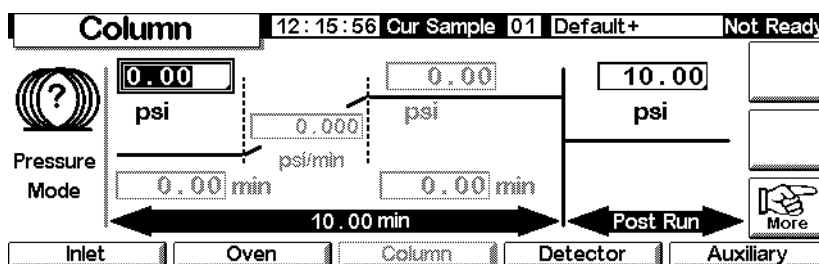

2. Note the question mark at the left, indicating that the column is not defined. To define it, press More, select Configure Column, and press Enter to display the next screen.

Status / Settings / Column / More / Configure Column / Enter

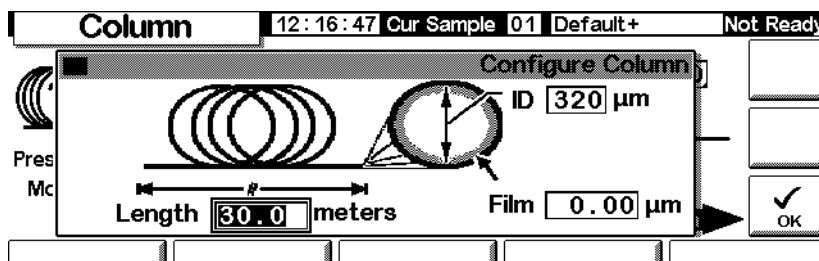

3. Enter values for Length, ID (internal diameter), and Film (thickness).
4. Press OK.

If you do not know the column dimensions—they are usually supplied with the column—or if you do not wish to use the GC calculating features, enter 0 for either length or ID. The column will be *not defined* and you will only be able to use pressure setpoints with a split/splitless inlet, or total flow with a purged packed inlet.

Column modes

Flow modes

Flow rates are corrected to NTP (normal temperature and pressure, 25°C and 1 atmosphere).

- *Constant flow*—Maintains a constant mass flow rate of carrier gas in the column throughout the run. If the column resistance changes due to a temperature program, the column head pressure is adjusted to keep the flow rate constant. This can shorten runs significantly.
- *Ramped flow*—Increases the mass flow rate in the column during the run according to a program you enter.

Pressure modes

Pressures are gauge pressures—the difference between the absolute pressure and the local atmospheric pressure. Because most detectors present little resistance to the column flow, the gauge pressure at the column head is usually the same as the pressure difference between column inlet and exit. The mass selective detector and the atomic emission detector are two exceptions.

- *Constant pressure*—Maintains a constant gauge pressure at the head of the column throughout the run. If the column resistance changes, the gauge pressure does not change but the mass flow rate does.
- *Ramped pressure*—Increases the column head gauge pressure during the run according to a program you enter

Column modes vs. inlet modes

The column mode selected changes the inlet mode(s) available. For example, if using a column pressure mode, only pressure modes will be available for most inlet types.

To select a column mode

Display this screen.

Status / Settings / Column / More

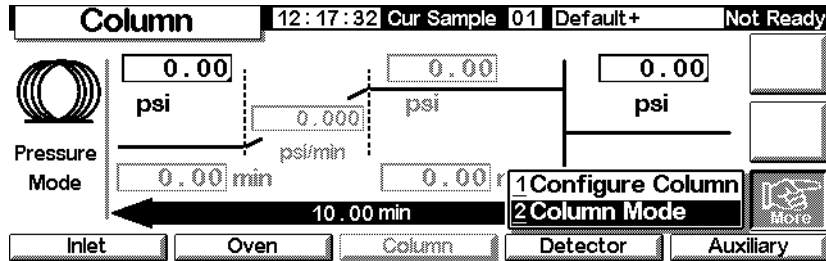

1. Select Column Mode and press Enter to display the next screen.

Status / Settings / Column / More / Column Mode / Enter

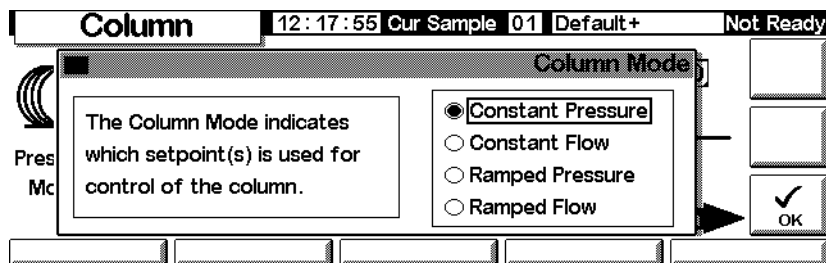

2. Select the column mode you want. Press OK.

This completes column mode selection.

Warning Set your column parameters with your oven at its initial temperature.

Some pneumatic setpoints will change with oven temperature because of changes in column resistance and in gas viscosity. This may be confusing (or alarming) if you see pneumatic setpoints changing when the oven temperature changes. However, the flow condition in the column remains as specified by the column mode (constant flow or pressure, ramped flow or pressure) and the initial setpoint values.

Initial column flow or pressure

Recommended starting flows and pressures

See the [Table 6](#) and [Table 7](#) for recommended flows and pressures for various column sizes. These are close to optimum for a wide variety of components.

Table 6. Column Size and Carrier Gas Flow Rate

Column type	Column size	Carrier gas flow rate, mL/min		
		Hydrogen	Helium	Nitrogen
Capillary	50- μ m id	0.5	0.4	
	100- μ m id	1.0	0.8	
	200- μ m id	2.0	1.6	
	250- μ m id	2.5	2.0	
	320- μ m id	3.2	2.6	
	530- μ m id	5.3	4.2	
Packed metal	1/8-in. id		30	30
	1/4-in. id		60	30-60
Packed glass	2-mm id		30	30
	4-mm id		30-60	30-60

These flow rates, in mL/min at NTP (25°C and 1 atm) are recommended for all column temperatures.

For capillary columns, flow rates are proportional to column diameter and are 20% lower for helium than for hydrogen.

Table 7. Recommended Gas Pressures for Capillary Columns

Length, m	Recommended gas pressure, psi (kPa)				
	Inside diameter				
	0.10 μm	0.20 μm	0.25 μm	0.32 μm	0.53 μm
10	25 (170)	6 (40)	3.7 (26)	2.3 (16)	0.9 (6.4)
15	39 (270)	9 (61)	5.6 (39)	3.4 (24)	1.4 (9.7)
25	68 (470)	15 (104)	9.5 (65)	5.7 (40)	2.3 (16)
30	83 (570)	18 (126)	12 (80)	7 (48)	2.8 (19)
50		32 (220)	20 (135)	12 (81)	4.7 (32)
60		39 (267)	24 (164)	14 (98)	5.6 (39)

Split/Splitless inlet

If the column is *defined* (see [Configuring the column](#) on page 38), you can enter either flow or pressure, depending on which column mode you selected.

If the column is *not defined*, you can only enter pressure.

Purged packed inlet

If using a *defined* capillary column (see [Configuring the column](#) on page 38), you can enter only column head pressure.

If the column is *not defined*, you can enter only total flow rate.

To set initial flow or pressure

Display this screen.

Status / Settings / Column

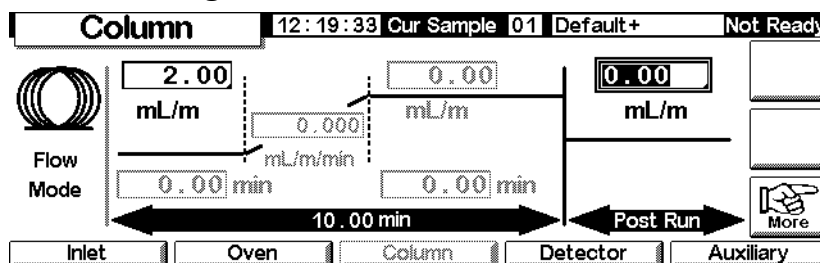

1. Scroll to the psi (pressure mode) or mL/min (flow mode) field.
2. Type the desired initial value, followed by Enter.

Flow or pressure programming

If you selected either the ramped pressure or ramped flow column mode, the column screen contains entries for setting up a single-ramp program.

You begin with an initial value, either pressure or flow, and an initial time. At the end of that time, the pressure or flow ramp begins and runs until it reaches the final value. It remains at that value for a specified time.

The oven program determines the length of the run. If a flow or pressure program ends before the analytical run does, the flow (or pressure) remains at the last final value. If the oven includes a Post-Run period, you can enter a Post-Run pressure or flow for the column.

To create a flow or pressure program

Display this screen.

Status / Settings / Column

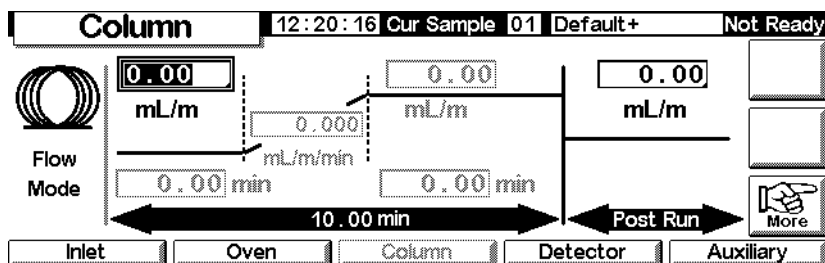

1. The column is in constant flow mode, which is why the ramp setpoints are grayed out. Press **More** and use the Column Mode screen (see [Column modes](#) on page 40) to change to Ramped Flow.

Status / Settings / Column

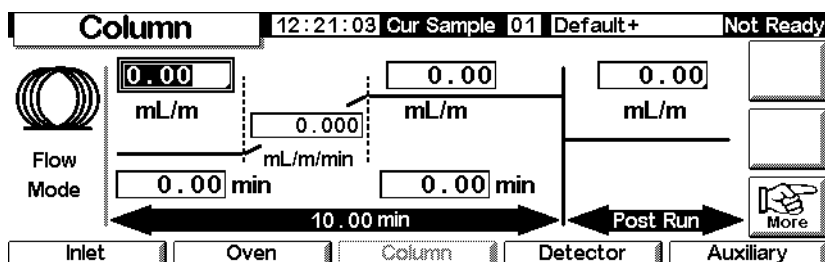

2. Enter the starting value in the mL/min field.
3. Use the ← and → keys and enter values in the remaining fields to complete the ramp. If desired, enter a Post Run value.
4. Use a similar procedure to set up a pressure program.

Auxiliary channels

Three additional auxiliary pressure control channels are available as an option. They are controlled by the Aux 3, Aux 4, and Aux 5 entries on the Auxiliary settings screen (Aux 1 and 2 are heater controls).

If an auxiliary channel is specified as the **Inlet** during column configuration (see [Configuring the column](#) on page 38), the channel allows run time programming as well as three-ramp pressure programming. The most common case of this is when a gas sampling valve is used.

Configuring thermal auxiliary type

Display this screen.

Status / Settings / Auxiliary / More

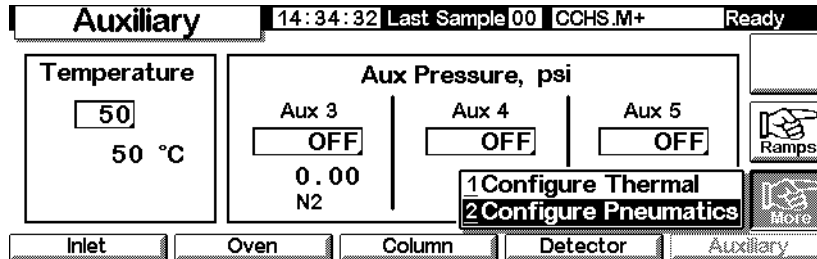

1. Select Configure Thermal.
2. Select the installed device type.

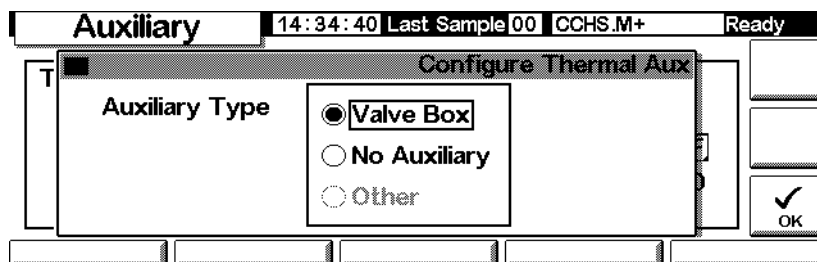

- Select Other for an MSD.
 - Select No Auxiliary to disable the zone.
3. Press OK.

Configuring pneumatics

Display this screen.

Status / Settings / Auxiliary / More

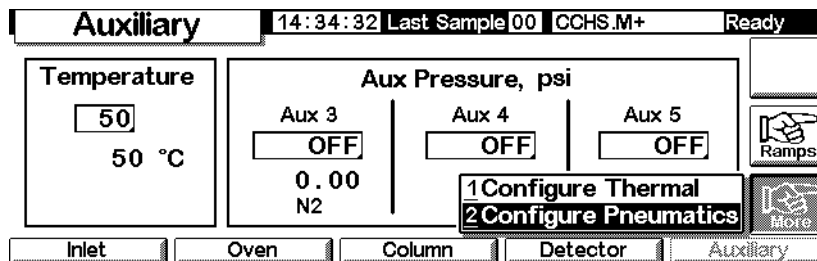

1. Select Configure Pneumatics.

2. Select the gas to use and the equilibration time (the time allowed for the pressure to stabilize before an error occurs) for the appropriate channels. Your gas selection should be what you have physically connected to the GC.

Do not use or select *air* as the gas for the column input channel.

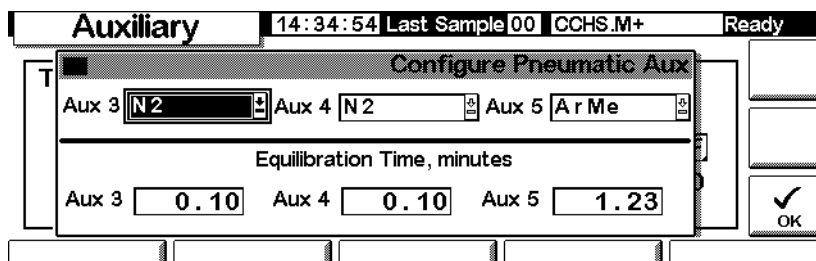

3. Press OK.

Warning

When hydrogen is used, dangerously high flows are possible if insufficient flow resistance is provided downstream of the supply tube.

Setting auxiliary temperature and pressure

Display this screen.

Status / Settings / Auxiliary

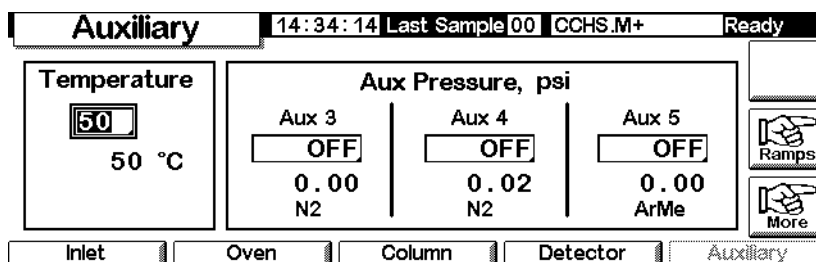

1. Set the temperature and pressures for the appropriate channels.
2. Press Esc.

Setting auxiliary temperature ramps

1. Display this screen.

Status / Settings / Auxiliary / Ramps

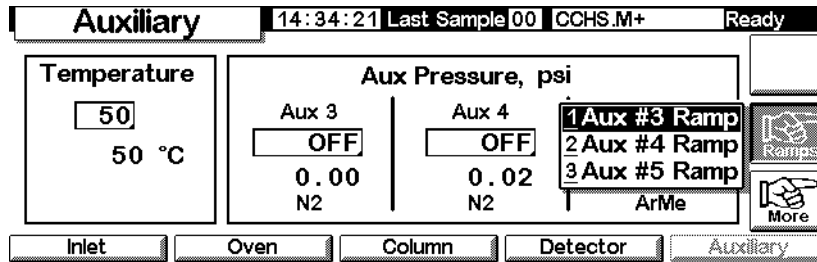

2. Select the ramp you want to set. A pressure ramp table for the selected Aux channel appears. The table for the Aux #3 Ramp is shown below. The others are identical. While this screen lists pressure values in psi units, you specify the units on the Inlet Setup screen.

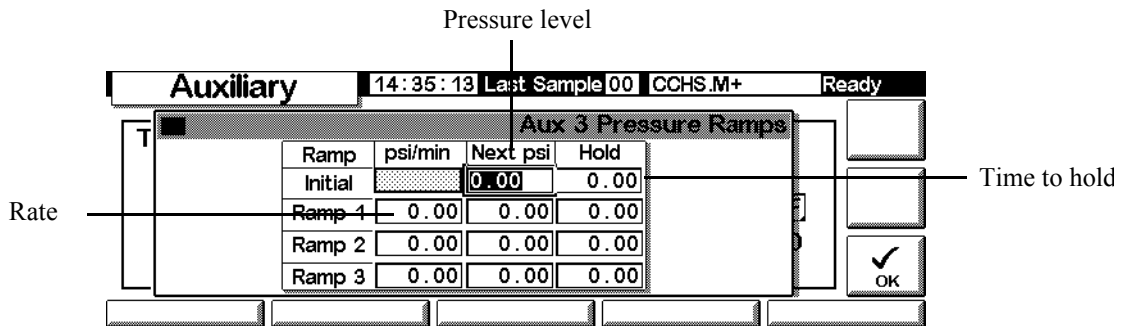

3. Set up to three ramps, entering values for a pressure level, a time to hold that pressure, and the rate at which to move to the next pressure level.
 - To disable a ramp and all further ramps, enter a rate of 0.0.
4. Press OK.

Solving flow and pressure problems

A gas does not reach the setpoint pressure or flow

If the condition persists longer than the time specified for that stream, the inlet or detector will shut down. The time depends on the specific device involved. Possible causes/corrections include:

- The gas supply pressure is too low to reach the setpoint. The pressure at the supply should be at least 10 psi greater than the desired setpoint.
- A large leak is present somewhere in the system. Use an electronic leak detector to find leaks; correct them. Don't forget to check the column—a broken column is a very large leak.
- If you are using gas saver, be sure that the gas saver flow rate is high enough to maintain the highest column-head pressure during a run
- The flow is too low for the column in use
- The column is plugged or mis-installed
- The inlet or detector pressure sensor is not operating correctly. Contact your Agilent service representative.

If you are using a split/splitless inlet

- The split ratio is too low. Increase the amount of split flow.
- The inlet proportional control valve is stuck because of contamination or other fault. Contact your Agilent service representative.

If you are using a purge packed inlet

- The inlet control valve is stuck closed because of contamination or other fault. Contact your Agilent service representative.

A gas exceeds the setpoint pressure or flow

Possible causes/corrections include:

- The pressure sensor for that device is not operating properly. Contact your Agilent service representative.

If you are using a split/splitless inlet

- The split ratio is too high. Decrease the split ratio.
- The proportional control valve is stuck closed. Contact your Agilent service representative.
- The trap on the split vent line is contaminated. Contact your Agilent service representative.

If you are using a purge packed inlet

- The inlet proportional control valve is stuck open. Contact your Agilent service representative.

The inlet pressure or flow fluctuates

A fluctuation in inlet pressure will cause variations in the flow rate and retention times during a run. Possible causes/corrections include:

- A small leak is present in the flow system. Use an electronic leak detector to find leaks; correct them. You should also check for leaks in the gas supply plumbing.
- Large restrictions are present in the split/splitless inlet, such as a blockage in a liner or the split vent trap. Make sure that you are using the correct liner. Replace liners with large pressure drops caused by design or tight packaging. If the liner does not appear to be causing the problem, the split vent trap may be blocked. Contact your Agilent service representative.
- Extreme changes in room temperature during runs. Correct laboratory temperature problem or move the instrument to a more suitable location.
- Large volumes have been added to the system (this may occur if you are using a sampling valve). Decrease the sample volume.

The measured flow is not equal to the displayed flow

You checked the flow at an inlet with a bubble flow meter, corrected the measurement to NTP conditions, and find that it does not match the flow you set. Possible causes/corrections include:

- Column length, internal diameter, or gas type is configured incorrectly. Enter the correct information. If a considerable amount has been cut off a capillary column, its actual length may no longer match the original. Correct the length value.
- A new pressure setpoint was not entered after constant flow mode was selected. Enter a new pressure setpoint each time constant flow is turned on or off.
- A short (<15 m) 0.58 to 0.75- μm id WCOT column is being used. Total flow is set for a high flow rate, which creates some pressure in the inlet and causes column flow even with a setpoint pressure of zero. With short, 530 to 750 μm columns, keep the total flow rate as low as possible (for example, 20 to 30 mL/min). Install a longer column with higher resistance (for example, 15 to 30 m).
- The split vent line may be partly plugged, creating an actual inlet pressure higher than the setpoint pressure. See [Split Vent Test \(Split/Splitless and PTV inlets only\)](#) on page 177.
- A Mass Selective Detector is in use and vacuum compensation is not selected

Automation

This section describes how to control the automation features of the GC using the Control Module. Items discussed are:

- Injector control
- The sequence
- The run table
- The clock table

Injector control

To set injection parameters

1. Display this screen.

Status / Automation / Injector

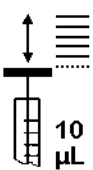
Injector		11:46:04	Last Sample 01	RUN.M	Not Ready
Plunger Pumps	<input type="text" value="5"/>	Sample Size	<input type="text" value="1.0 uL"/>	Viscosity Delay	<input type="text" value="0 sec"/>
				<input type="checkbox"/> Slow plunger	
Washes	Depth Offset	Dwell Times			

2. Enter:

Plunger Pumps—The number of times to pump the plunger with the needle in the sample to expel bubbles before drawing up the measured sample amount.

Sample Size—The amount to be injected. The choices depend on the syringe size specified during setup.

Viscosity Delay—The number of seconds the plunger pauses at the top of the pump and inject strokes. This time allows viscous samples to flow into the vacuum created by the plunger.

Slow plunger—Reduces the plunger speed during injection from normal (about 100 $\mu\text{L}/\text{sec}$ with a 10 μL syringe) to about 5 $\mu\text{L}/\text{sec}$.

Wash parameters

1. Display this screen.

Status / Automation / Injector / Washes

Washes		12:05:33	Last Sample 01	Default+	Not Ready
	Sample	Solvent A	Solvent B		
Pre Washes	<input type="text" value="0"/>	<input type="text" value="0"/>	<input type="text" value="0"/>		<input type="text"/>
		<input type="text" value="0"/>	<input type="text" value="0"/>	Post Washes	<input type="text"/>
<input type="text"/>	<input type="text"/>	<input type="text"/>	<input type="text"/>	<input type="text"/>	<input type="text"/>

2. The syringe can be washed with sample before drawing up the amount to be injected. It can also be washed with solvent both before (pre-washes) and after (post-washes) an injection. The order of events is:
 - Wash syringe with solvent A Solvent-A-Pre-Washes times
 - Wash syringe with solvent B Solvent-B-Pre-Washes times
 - Rinse syringe with sample Sample-Pre-Washes times
 - Draw up sample and make injection
 - Wash syringe with solvent A Solvent-A-Post-Washes times
 - Wash syringe with solvent B Solvent-B-Post-Washes times
3. Enter your choices, then press Esc to return to the previous screen.

Needle depth

1. Display this screen.

Status / Automation / Injector / Depth Offset

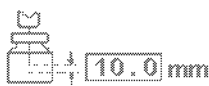
Depth Offset		12:05:40	Last Sample 01	Default+	Not Ready
This parameter allows an offset in the the depth of the syringe needle in the sample vial. It can prevent particles being drawn up into the syringe.	<input type="checkbox"/> Enable Offset				<input type="text"/>
		<input type="text" value="10.0"/>	mm		<input type="text"/>
<input type="text"/>	<input type="text"/>	<input type="text"/>	<input type="text"/>	<input type="text"/>	<input type="text"/>

2. The default value, 0 mm, includes a small safety factor to avoid striking the bottom of the vial. This parameter can also be used to sample headspace instead of the liquid or solid sample. See your Sampler manual.
3. Enter your choices, then press Esc to return to the previous screen.

Dwell times

1. Display this screen.

Status / Automation / Injector / Dwell Times

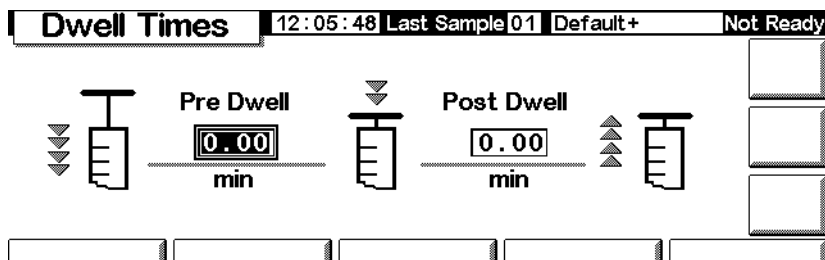

2. Enter your choices. For most uses, both dwell times will be zero. This gives a fast injection with a minimum of boil-out from a hot needle.
3. Press Esc to return to the previous screen.

Solvent parameters

Depending on the GC firmware you have, the injector type and firmware, and the turret size of your GC, you can set various solvent parameters. To access these parameter settings:

1. Display this screen.

Status / Setup / Automation / Injector

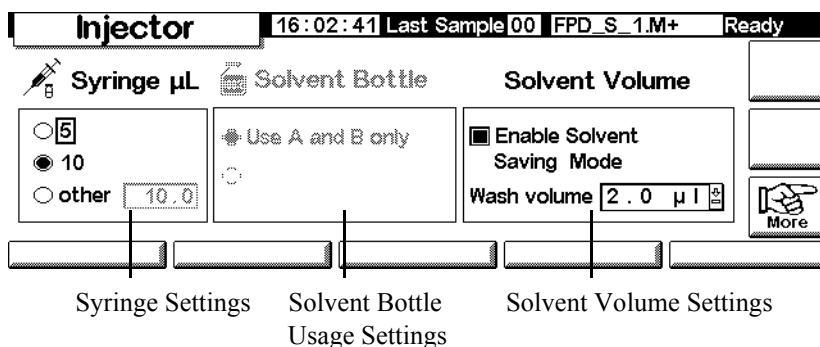

This screen is an example of what might appear. The screen that appears will have different settings, based on your GC's configuration of the dependent items listed above.

2. Set the parameters as necessary.
3. Press Esc.

Syringe capacity

Enter the size of the syringe in milliliters.

Solvent bottle usage

Newer versions of the GC (firmware versions A.05.00 and higher) support extended solvent capacity, which is useful when you run large numbers of samples. If the method specifies solvent A or B usage, your solvent capacity can be extended as follows:

Injector	Turret type	Extended solvent setting
G2613A	3 vial position	Use A, B, and B2
G2913A	1	A, A2, A3, and B, B2, and B3
6850 Auto-matic Liquid Sampler	All	Use A, A+ and B, B+

Remember that the solvents you use (A and/or B) are set within the method. See [Wash parameters](#) on page 53. Refer to the GC User Information CD-ROM for more information about solvent bottle positions in your autoinjector or auto sampler system.

Waste bottle usage

If the waste bottle control does not appear on the screen, press **More** to select that option. The positions containing bottles to use for waste (*A, B, or Alternate between A and B*).

Solvent volume

Solvent volume allows you to conserve solvent by adjusting the amount used to wash the syringe.

Enable or disable saver mode and specify the amount of solvent to draw into the syringe on each wash. The default, if disabled, is 80% of the syringe volume.

Injector fan

If the fan control does not appear on the screen, press **More** to select that option. Normally, leave the fan on to help cool the injector and keep your samples stable. Note that the fan will briefly turn off once per day for a short time. This extends fan life.

Sequence parameters

The *Sequence* is a list of samples to be analyzed using the active method. The samples may be either locations of vials in an injector turret or positions of a stream selection valve. The sequence list is not saved with a method.

To set up the sequence of samples to be analyzed

Display this screen.

Status / Automation

The screenshot shows the 'Automation' screen with the following parameters and controls:

- Time: 11:57:22, Last Sample: 00, Default+, Not Ready
- First Vial: 1, Last Vial: 1 0, # Inj per Vial: 1 0
- Sequence Type: Injector, Valve, none
- Repeat Sequence: repeat, no repeat
- Repeat Valve Range: 1 0
- Buttons: START, Stop Seq, PAUSE
- Bottom buttons: Injector, Valves, Clock Table, Run Table

To enter the injector parameters

1. Select **Injector** for Sequence type. The screen is shown above.
2. Enter these parameters:
 - *First and Last Vial*—The lowest and highest numbered turret position to be sampled. See your sampler manual for the numbering scheme.
 - *# Inj per Vial*—The number of times to analyze each sample before moving on to the next one. Default is 1.
 - *Repeat Sequence*—Select **repeat** to have the sequence start over at the beginning. Select **no repeat** to have the sequence stop after all samples have been analyzed.

To enter the valve parameters

1. For Sequence type, select **Valve**.

Status / Automation

Automation		11:58:44	Last Sample 00	Default+	Not Ready
First Position	Last Position	# Inj per Position	Sequence Type		
<input type="text" value="1"/>	<input type="text" value="1"/> 0	<input type="text" value="1"/> 0	<input type="radio"/> Injector <input checked="" type="radio"/> Valve <input type="radio"/> none		
Repeat Valve Range		Repeat Sequence		<input type="radio"/> repeat <input checked="" type="radio"/> no repeat	
<input type="text" value="1"/> 0				<input type="button" value="START"/> <input type="button" value="Stop Seq"/> <input type="button" value="PAUSE"/>	
<input type="button" value="Injector"/>	<input type="button" value="Valves"/>	<input type="button" value="Clock Table"/>	<input type="button" value="Run Table"/>		

2. Enter these parameters:

- *First and Last Position*—The lowest and highest numbered valve position to be sampled
- *# Inj per Position*—The number of analyses to make at each valve position before moving on to the next one. Default is 1.
- *Repeat Valve Range*—The number of times the valve should cycle through its range of positions, making analyses at each position (possibly multiple runs)
- *Repeat Sequence*—Select *repeat* to have the sequence start over at the beginning. Select *no repeat* to have the sequence stop after all streams have been analyzed.

To operate without a sequence

For Sequence type, select None.

Controlling a sequence

To start the sequence

Press **Start** on the Status screen or the Status/Automation screen.

To pause the sequence

Press **Pause** on the Status/Automation screen to pause (halt) the sequence. If a run is in progress, the GC will complete the run and then pause the sequence.

The word **PAUSE** will appear on the screen and blink while the sequence is paused.

Status / Automation / Pause

Automation			12:00:18	Cur Sample 00	Default+	Not Ready
First Vial	Last Vial	# Inj per Vial	Sequence Type		Repeat Sequence	
1	1 0	1 0	<input checked="" type="radio"/> Injector <input type="radio"/> Valve <input type="radio"/> none		<input type="radio"/> repeat <input checked="" type="radio"/> no repeat	
Repeat. Valve Range			PAUSE		START	
1 0			Injector		Stop Seq	
			Valves		PAUSE	
			Clock Table		Run Table	

To resume a paused sequence

Press **Pause** again. The sequence will resume with the sample run following the last one before the sequence paused.

To cancel a paused sequence

Press **Stop Seq.**

To stop the sequence

The **Stop** button on the Status screen stops the run and sequence. The **Stop Seq** button on the Automation screen stops the sequence only. The current run continues. A stopped sequence cannot be resumed.

Run Table

A *Run Table* is a list of events to be performed at specified times in every run. Typical events are changing signal attenuation, zeroing after a signal disturbance, and switching a valve. The Run Table is saved as part of the method.

All times in the Run Table are *run* times, that is, the elapsed time in minutes since the start of the run.

To show the present content of the Run Table, display this screen.

Status / Automation / Run table

Time	Event	Value
	End Of Table	

- *To remove an event:* Select the event and press Delete.
- *To add an event:*
 - a. Press Add to display a list of the events available. The list is a function of the hardware installed in this GC. See [Table 8](#) for a list of all available events.

Status / Automation / Run Table / Add

- b. Select the desired event.
 - c. Enter the execution time (minutes after Start) and a value, if appropriate. Press OK. The new event will be inserted in the Run Table in the correct time order.
- *To modify an event:* Select and Delete the event, then Add the modified one.

Table 8. Run Table Events

Event	Event values	Signal
Valve 1	ON / OFF	
Valve 2	ON / OFF	
MultiPort Valve	Position	
Signal Zero	-500,000 to 500,000 or none	Analog, digital
Signal Attenuation	0 to 10	Analog
Signal Range	0 to 13	Analog
Detector Negative Polarity	ON / OFF	Analog, digital
Auxiliary Temperature	ambient+25°C to 200°C	
Auxiliary #3 Pressure	0 to 689 kPa, 100 psig, or 6.89 bar	
Auxiliary #4 Pressure	0 to 689 kPa, 100 psig, or 6.89 bar	
Auxiliary #5 Pressure	0 to 689 kPa, 100 psig, or 6.89 bar	
Store Signal Value	none	Analog, digital
Signal Zero - Value	none	Analog, digital

Valve events

These events provide direct control of valve actions. Enter the times you want to switch the valves ON and OFF in the table.

Signal Zero event

- Enter a value to be subtracted from all future signal values.

OR

- Leave the event value blank. The GC stores the value of the signal at the time of the event and subtracts that value from all future signal values.

Signal Range event and Signal Attenuation event

- The Signal Range event scales the signal available through the 0–1 V or 0–10 V, and 0–1 mV outputs.
- The Signal Attenuation event scales the 0–1 mV output only.

Both events are binary scalars—a change of 1 in the event value scales the signal by a factor of 2

Store Signal Value event and Signal zero - value event

These two events are used together to restore the baseline level after a disturbance, such as a valve operation, has shifted it.

- *Store Signal Value*—This event stores the value of the signal at the time of the event. It should occur on baseline.
- *Signal Zero - Value*—This shifts the disturbed baseline by subtracting the value stored by a Store Signal Value event from all future signal values. When these two events surround a baseline-shifting action, the effect is to bring the new baseline to the previous level. The Store event must occur before the baseline shift, and the Zero - Value event must occur after the baseline has stabilized at the shifted level. See [Figure 2](#).

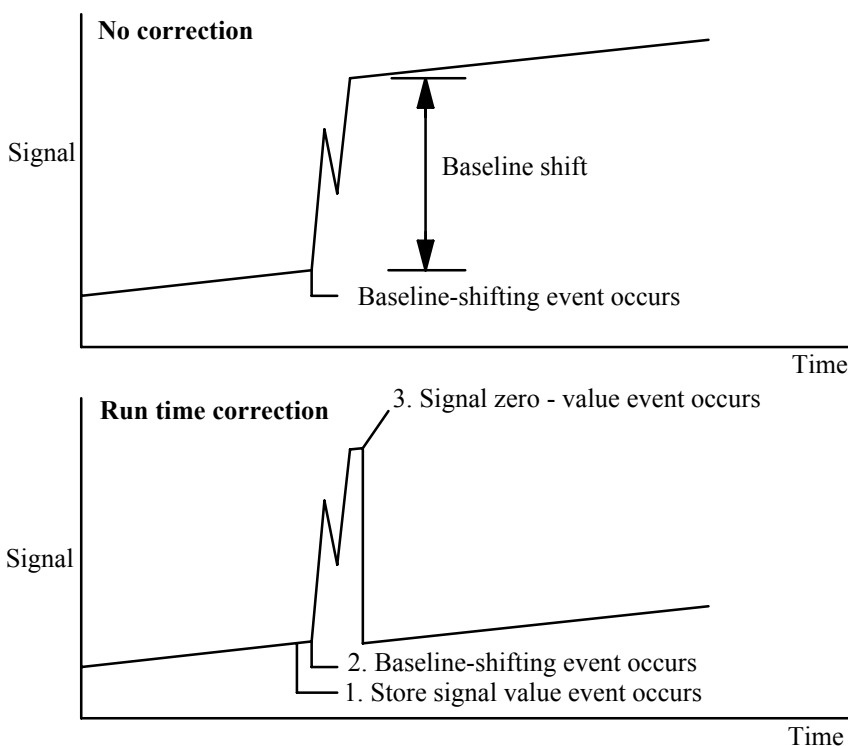

Figure 2. Correcting baseline level shifts

Clock Table

The *Clock Table* is a list of events to be performed at specified times of day. Examples include loading a method, making a blank run, and starting the sequence. The Clock Table is not saved with a method.

Be aware that the Clock Table does not include a calendar. It will do the same thing every day, including weekends, holidays, and vacations.

To show the present content of the Clock Table, display this screen. All times are *clock* times, that is, the time of day as measured by the GC's internal clock. Times are on a 24-hour scale.

Status / Automation / Clock Table

Time	Event	Value
End Of Table		

- *To remove an event:* Select the event and press **Delete**.
- *To add an event:* Press **Add** to display a list of the events available. The type of events in the list depends on the hardware installed in this GC.

Status / Automation / Clock Table / Add

Select the desired event, enter the execution time (24-hour clock) and a value, if appropriate, and press **OK**. The new event will be inserted in the clock table in the correct time order.

- *To modify an event:* Select and **Delete** the event, then **Add** the modified one.

Table 9. Clock Table Events

Event	Event values
Valve 1	ON / OFF
Valve 2	ON / OFF
MultiPort Valve	ON / OFF
Start Blank Run	none
Start Sequence	none
Go Into Pre-Run	none
Column Compensation Run	none
Load GC Method	Method Name

Split/Splitless Inlet

Using hydrogen

Warning When using hydrogen (H₂) as a carrier gas or fuel gas, be aware that hydrogen gas can flow into the oven and create an explosion hazard. Therefore, be sure that the supply is off until all connections are made and ensure that the inlet and detector column fittings are either connected to a column or capped at all times when hydrogen gas is supplied to the instrument.

Warning Hydrogen is flammable. Leaks, when confined in an enclosed space, may create a fire or explosion hazard. In any application using hydrogen, leak test all connections, lines, and valves before operating the instrument. Always turn off the hydrogen supply at its source before working on the instrument.

Options

There are two options for the split/splitless inlet:

- *Standard*—the pressure range is 0 to 100 psi. It is appropriate for most columns.
- *High-pressure*—the pressure range is 0 to 150 psi. It is useful with very small diameter capillary columns that offer considerable resistance to gas flow.

To determine the option that you have, check the configuration of the GC (Status / Settings / Configure). This screen displays the pressure range for the inlet.

Inlet Modes

The inlet also has four operating modes:

- *Split*—is divided between the column and a vent flow.
- *Splitless*—is not divided. Most of it enters the column. A small amount is purged from the inlet to avoid excessive peak broadening and solvent tailing.

- *Split with a pressure pulse*—is similar to split mode, except that the inlet pressure is raised before and during injection and returned to normal at a user-specified time. Total flow is increased so that the split ratio does not change. This special kind of “programming” is independent of flow or pressure programming (see [Split mode](#) on page 72).
- *Splitless with a pressure pulse*—is like Split with a pressure pulse mode, but splitless.

The split/splitless inlet has a gas saver feature that reduces the flow of carrier into the inlet and out the split vent after the injection is complete. It does not alter the flow through the column. See [Gas saver](#) on page 77 for details.

The septum purge line is near the septum where the sample is injected. A small amount of carrier gas exits through this line to sweep out any bleed. This flow rate is set automatically, as shown in [Table 10](#).

Table 10. Septum Purge Flows

Carrier	Septum purge
He, N ₂ , 95%Ar/5%Me	3 mL/min
H ₂	6 mL/min

Inlet and column

The inlet and column controls are related, and the relationship depends on whether or not the column is configured. We strongly recommend that you set up the GC in this order:

1. Configure the column (see [Configuring the instrument](#) on page 12). If you do not, only the pressure modes of the column and inlet can be used. The flow-dependent features of the inlet, such as setting a split ratio directly, are not available.
2. Select the column mode (see [Column modes](#) on page 40).
3. Program column flow or pressure, if desired (see [Flow or pressure programming](#) on page 44).
4. Set up the inlet (see [Inlet setup](#) on page 67).
5. Set up the oven ([Oven setup](#) on page 149).

- Configure the detector (see [Thermal Conductivity Detector](#) on page 125, [Flame Ionization Detector](#) on page 134, [The Microcell Electron Capture Detector](#) on page 144, or [The Flame Photometric Detector \(FPD\)](#) on page 157).

Inlet setup

To set up the inlet:

- Display this screen.

Status / Setup / Inlet Setup

The screenshot shows the 'Inlet Setup' screen with the following settings:

- Carrier Gas:** He (selected), H2, N2
- Units:** psi (selected), kPa, bar
- Adjustments:** none (selected), Vacuum Correct, Pressure Correct (0.00 psi)

- Select the carrier gas you will use.
- Select the pressure units you prefer ([Table 11](#) shows the conversions).

Table 11. Pressure Unit Conversions

To convert	to	Multiply by
psi	bar	0.0689476
	kPa	6.89476
bar	psi	14.5038
	kPa	100
kPa	psi	0.145038
	bar	0.01

- Select pressure adjustments, if needed.
 - Vacuum Correct**, if the column empties into a vacuum. For example, you may be using a Mass Selective Detector or mass spectrometer.
 - None**, if pressure is normal. This setting is the case for most detectors.
 - Pressure Correct**, if another condition is involved.

Prep run

When you are performing analyses using manual injection and gas saver, splitless mode, and/or pressure pulse, the GC will display "Waiting for prep run" and one or more of these messages:

- "Gas saver active"
- "Inlet purging"
- "Inlet pulse inactive"

In these cases, you must press the **Prep Run** key to reset the setpoints, wait for the "Ready for" message, and then make the injection and press **Start**.

If this is not practical, you can have the GC issue an automatic Prep Run command at the end of each run. To do so, display this screen.

Status / Setup / Automation / Auto Prep Run

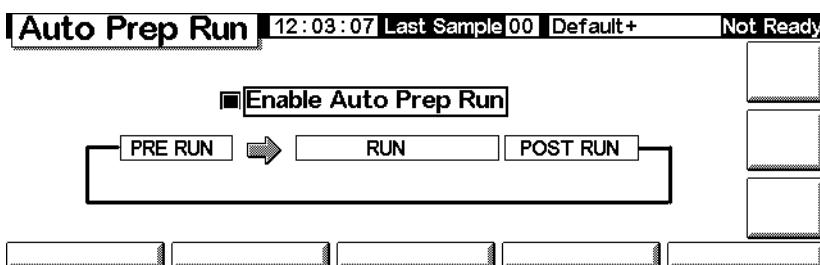

Select **Enable Auto Prep Run** and press **Esc**.

This disables Gas Saver and raises the inlet pressure to the Pulse Pressure level immediately. The inlet purge valve closes. Deselect **Enable Auto Prep Run** when you are finished making runs to conserve carrier gas.

It is usually best to disable *Auto Prep Run*. This function applies only to the split/splitless inlet in splitless mode and is equivalent to pressing **Prep run**.

Setting the inlet mode

1. Display this screen. This example shows that the GC is in splitless mode.

Status / Settings / Inlet / More / Inlet Mode / Enter

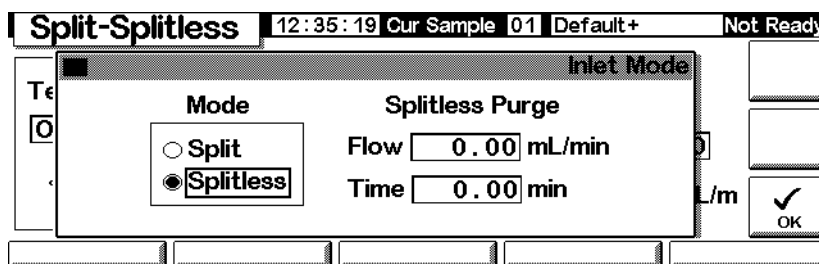

2. Select the mode you prefer and press OK.

Split/Splitless terms

Following are terms used in relation to the Split/Splitless inlet. Many are fields on screens that you see when using this inlet.

- *Flow*—The flow, in mL/min, from the purge vent, at Purge Start. You will not be able to specify this value if operating with your *column not configured*.
- *Pressure*—Actual and setpoint inlet pressure before and after the pressure pulse or vent period (measured in psi, bar, or kPa). This is the starting point of a pressure program, column head or the fixed pressure if a program is not used.
- *Pulse pressure*—The inlet pressure you desire at the beginning of a run. The pressure rises to this setpoint after Prep Run is pressed and remains constant until Pulse time elapses, when it returns to Pressure.
- *Pulse time*—Inlet pressure returns to its normal setpoint at this time after Start Run.
- *Purge flow*—The flow of carrier gas, in mL/min, from the purge vent, at Purge Start. The column must be configured.
- *Purge time*—The time, measured from Start Run, when sample transfer ends (purge valve opens). Set purge start 0.1 to 0.5 minutes before pulse time.
- *Split flow*—Flow, in mL/min from the split/purge vent. This field is not available if your column is not configured.
- *Split ratio*—The ratio of split flow to column flow. This field is not available if your column is not configured.

- *Temp*—Actual and setpoint initial inlet temperatures.
- *Total flow*—The total flow into the inlet, the sum of the split flow, column flow, and septum purge flow, displayed during a Pre-run (Pre-run light is on and *not* blinking) and during a run before Purge Start. You cannot enter a setpoint at these times. At all other times, Total flow will have both setpoint and actual values. When you change total flow, the split ratio and split flow change while column flow and pressure remain the same. When a pressure pulse is used, total flow increases to keep the split ratio constant.

Pressure pulse modes

The pressure pulse modes increase inlet pressure just before the beginning of a run and return it to the normal value after a specified amount of time. The pressure pulse sweeps the sample out of the inlet and into the column faster, reducing the chance for sample decomposition in the inlet. If your chromatography is degraded by the pressure pulse, a retention gap may help restore peak shape.

Pressure pulses may be used in either split or splitless mode and can be combined with column pressure or flow programming. The pressure pulse takes precedence over the column pressure or flow ramp, as shown in [Figure 3](#).

The pressure pulse must start before the sample is injected. The GC will do this automatically if you are using an automatic injector or a sequence.

If you are using manual injection, you must press Prep Run to start the pulse and wait for the "Ready for manual inj" message.

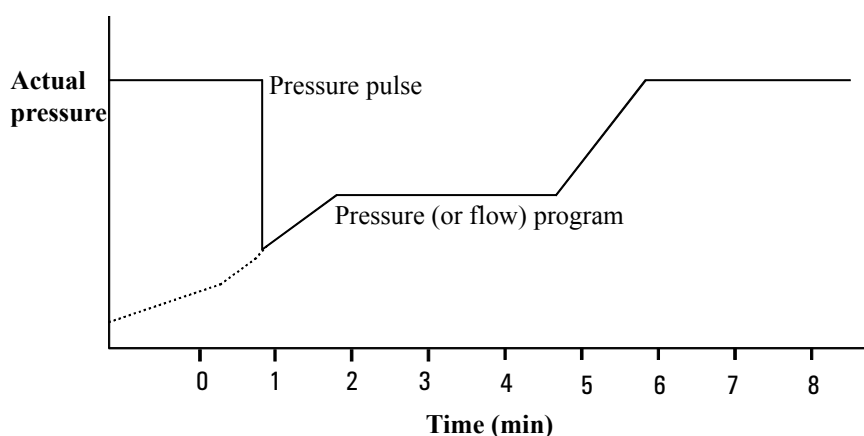
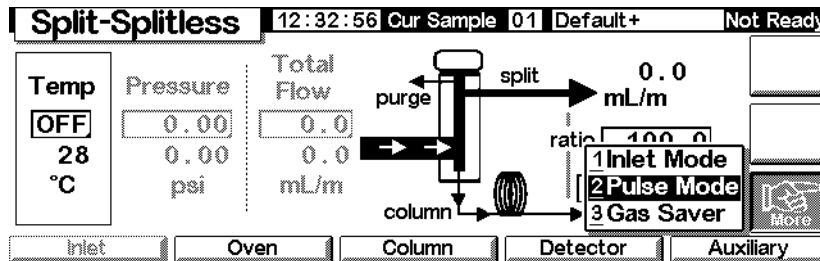

Figure 3. Pressure pulse and column flow or pressure

To set up a pressure pulse

1. Set up the flow conditions through the column, including a flow or pressure program (see [Flow or pressure programming](#) on page 44) if desired. Then display this screen.

Status / Settings / Inlet / More



2. Select Pulse Mode and press Enter to display the next screen.

Status / Settings / More / Pulse Mode / Enter

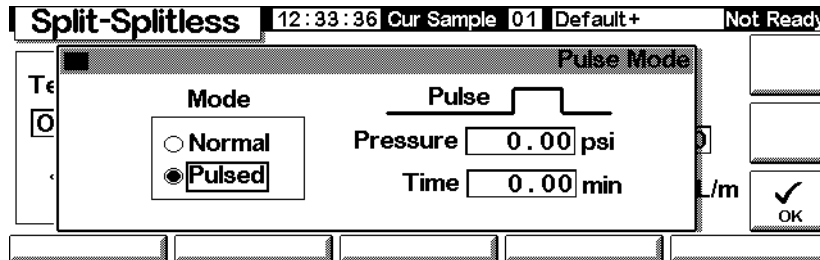

3. Select Pulsed. Enter values for Pressure and Time.
 - *Pressure*—the inlet pressure from Prep Run to Pulse Time.
 - *Time* (minutes after Start)—the time when the inlet pressure changes from Pulse Pressure to the pressure called for by the flow or pressure program (see [Flow or pressure programming](#) on page 44).
4. Press OK to accept these values or Esc to cancel.

Split mode

Pneumatics

During a split injection, a liquid sample is rapidly vaporized in a hot inlet. A small amount of the vapor enters the column while the rest exits through the split/purge vent. Split ratio, which is the ratio of column flow to split flow, is controlled by the user. Split injections are mainly used for high concentration samples when you can afford to lose most of the sample out the split/purge vent. It is also used for samples that cannot be diluted.

[Figure 4](#) shows the pneumatics for this inlet in split mode operation.

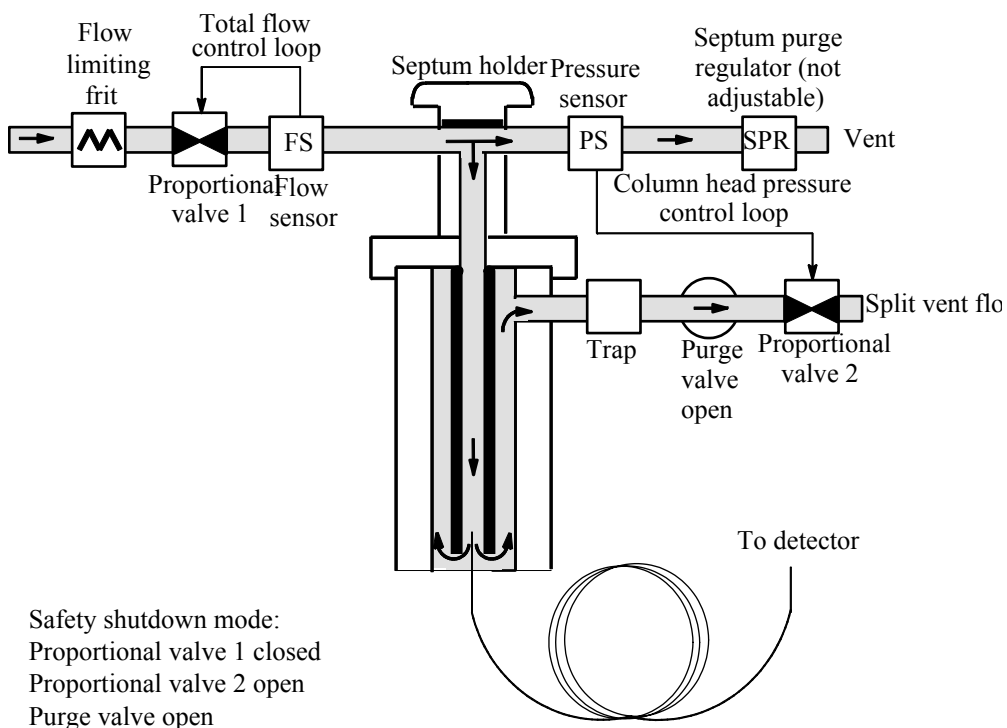

Figure 4. Split flow pneumatics

To use split mode with the column configured

1. Verify that the column is in split mode and either Constant Flow or Ramped Flow mode. See [Column modes](#) on page 40.
2. Display this screen.

Status / Settings / Inlet

The screenshot shows the 'Split-Splitless' status screen. At the top, it displays '14:15:09 Last Sample 00 FPDONMAN.M+ Not Ready'. The main area is divided into several sections:

- Temp:** A dropdown menu is set to 'ON', and the temperature is 33 °C.
- Pressure:** Two readouts show 0.00 psi.
- Total Flow:** Two readouts show 0.0 mL/m.
- Flow Diagram:** A schematic shows 'purge' and 'split' flows. The 'split' flow is 0.0 mL/m, and the 'ratio' is 50.0.
- Column Flow:** A readout shows 0.00 mL/m.
- Buttons:** 'Inlet', 'Oven', 'Column', 'Detector', and 'Auxiliary' are visible at the bottom.

3. Set Temp.
4. Enter either the `ratio` or `column` flow. The instrument calculates and displays the other value.
5. Set `column` mL/min.

To use split mode with the column not configured

Display this screen.

Status / Settings / Inlet

The screenshot shows the 'Split-Splitless' status screen with unconfigured values. At the top, it displays '12:36:53 Cur Sample 01 Default+ Not Ready'. The main area is divided into several sections:

- Temp:** A dropdown menu is set to 'OFF', and the temperature is 27 °C.
- Pressure:** Two readouts show 46.89 psi.
- Total Flow:** Two readouts show 0.0 mL/m.
- Flow Diagram:** A schematic shows 'purge' and 'split' flows. The 'split' flow is '? mL/m', and the 'ratio' is '?'.
- Column Flow:** A readout shows '? mL/m'.
- Buttons:** 'Inlet', 'Oven', 'Column', 'Detector', and 'Auxiliary' are visible at the bottom.

1. If necessary, change the inlet mode to split mode.

2. Set Temp and Pressure. Measure flow out of the split vent using a flow meter.

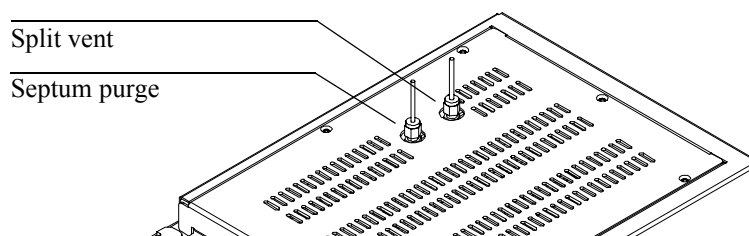

Subtract split vent flow and septum purge flow (see [Table 10](#) for nominal septum purge flows by carrier gas type) from Total flow to get column flow.

3. Calculate the split ratio. Adjust as needed.

$$\text{Split ratio} = \frac{\text{Split flow}}{\text{Column flow}}$$

Splitless mode

Pneumatics

In this mode, the purge valve is closed during the injection and remains so while the sample vaporizes in the liner and transfers to the column. At a time after injection that you specify, the purge valve opens to sweep any vapors left in the liner out the split vent. This avoids solvent tailing that would occur due to the large inlet volume and small column flow rate. See [Figure 5](#).

If you are using gas saver, the gas saver time should be *after* the purge time (see [Gas saver](#) on page 77 for details on the gas saver).

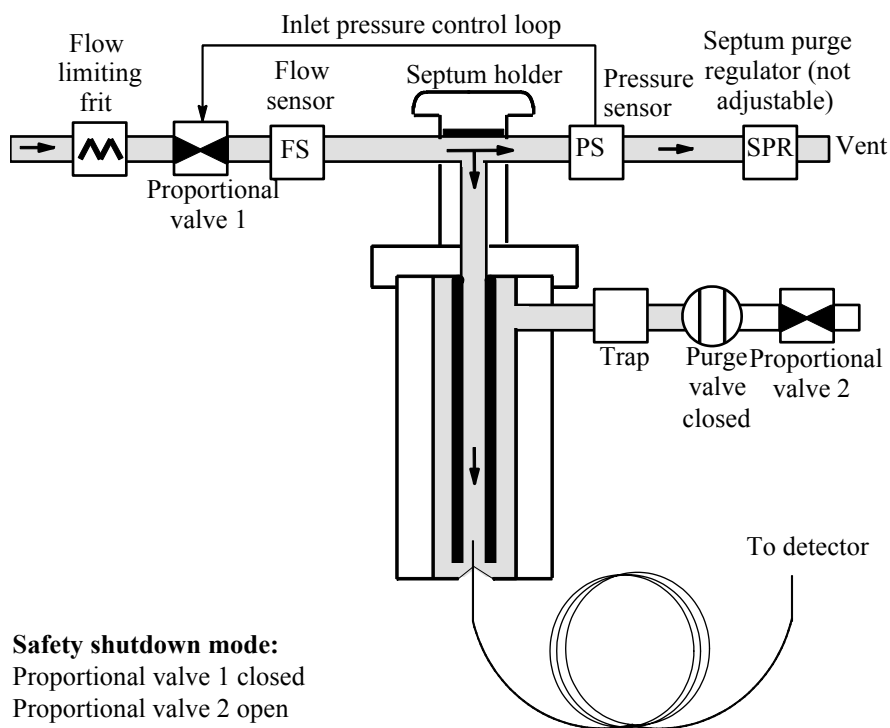

Safety shutdown mode:
Proportional valve 1 closed
Proportional valve 2 open
Purge valve open

Figure 5. Splitless flow diagram, prerun to purge time

Splitless mode injections

A successful splitless injection consists of these steps:

1. Vaporize the sample and solvent in a heated inlet.
2. Use a low flow and low oven temperature to create a solvent-saturated zone at the head of the column.
3. Use this zone to trap and reconcentrate the sample at the head of the column.
4. Wait until all, or at least most, of the sample has transferred to the column. Then discard the remaining vapor in the inlet—which is mostly solvent—by opening a purge valve. This eliminates the long solvent tail that this vapor would otherwise cause.
5. Raise the oven temperature to release the solvent and then the sample from the head of the column.

Some experimentation is needed to refine the operating conditions. Starting values for the critical parameters are shown in [Table 12](#).

Table 12. Splitless Mode Inlet Parameters

Parameter	Allowed setpoint range	Suggested starting value
Oven temperature	No cryo, 0°C to 375°C CO ₂ cryo, -20°C to 375°C	30°C below solvent boiling point
Oven initial time	0 to 999.9 minutes	≥ Inlet purge time
Inlet purge time	0 to 999.9 minutes	Liner volume / Column flow
Gas saver time	0 to 999.9 minutes	After purge time
Gas saver flow	15 to 1000 mL/min	15 mL/min greater than maximum column flow

To use splitless mode with the column configured

1. Verify that the column, carrier gas, and flow or pressure program (if used) are configured correctly.
2. Display this screen.

Status / Settings / Inlet

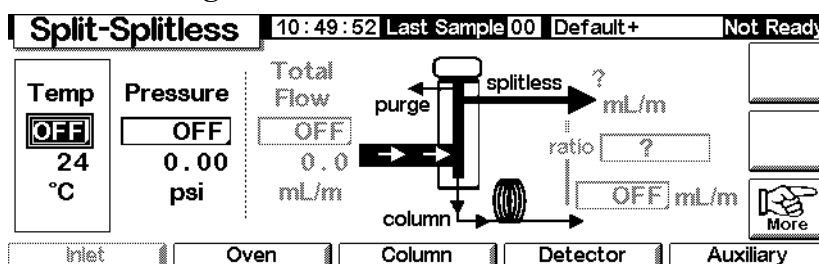

3. If necessary, change the inlet mode to splitless. See [Setting the inlet mode](#) on page 69.
4. Enter values for Temp and column mL/min.
5. Use Prep Run (see [Prep run](#) on page 68) before manually injecting a sample.

To use splitless mode with the column not configured

1. If necessary, change the inlet mode to splitless.
2. Display this screen.

Status / Settings / Inlet

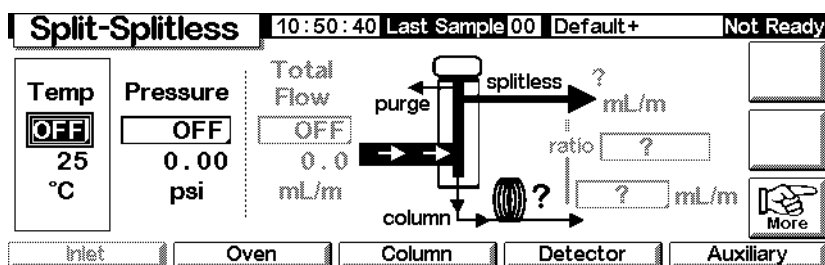

3. Enter values for Temp (the maximum is 375°C) and Pressure.
4. Use Prep Run (see [Prep run](#) on page 68) before manually injecting a sample.

Gas saver

Gas saver reduces carrier gas flow from the split vent after the sample is on the column. Column head pressure and flow rate are maintained, while purge and split vent flows decrease. Flows—except column flow—remain at the reduced level until you press Start (sequence or auto injector operation) or Prep Run (manual injection). See [Figure 6](#).

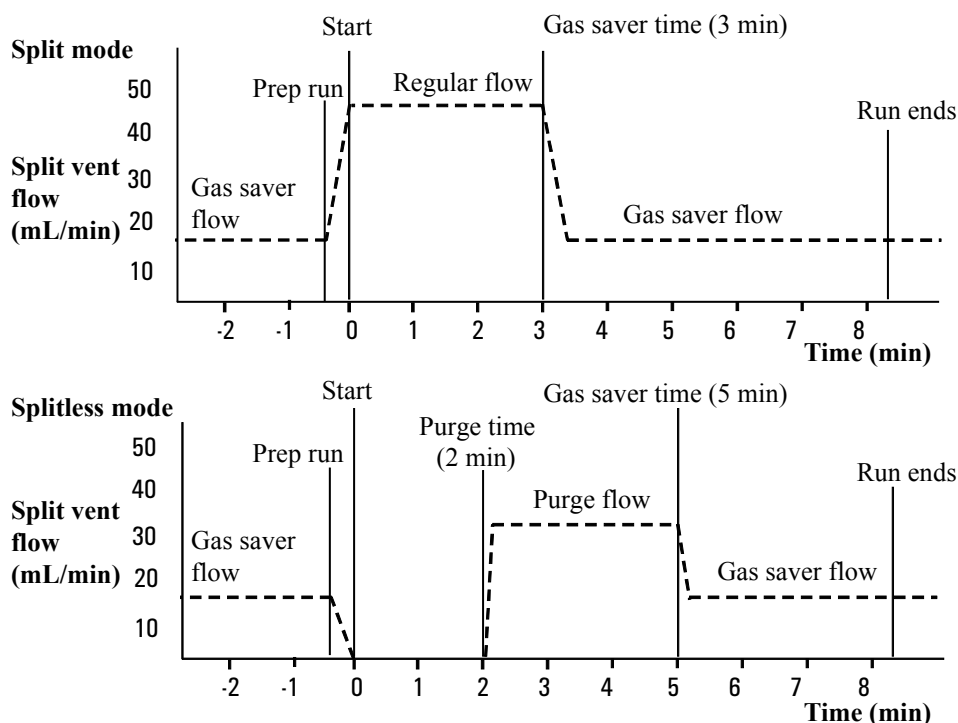
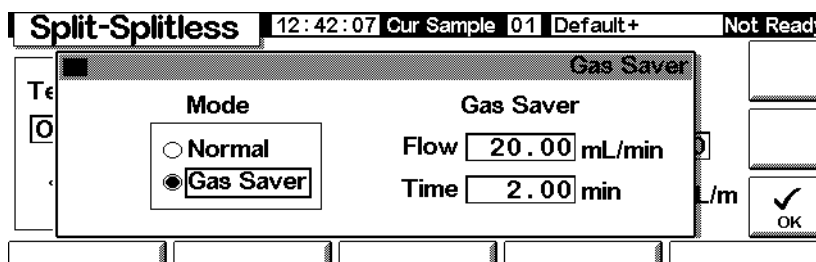

Figure 6. Gas saver operation

To configure gas saver

Display this screen.

Status / Settings / Inlet / More / Gas Saver / Enter



1. Select Gas Saver. Enter values for Flow and Time.
 - *Flow*—is the reduced flow level between sample runs.
 - *Time* (minutes after injection)—is when the normal flow changes to saver Flow. It remains at the reduced level until the next Prep Run event, whether manual or automatic.
2. Press OK to accept these values or Esc to cancel.

Purged Packed Inlet

Using hydrogen

Warning When using hydrogen (H₂) as a carrier gas or fuel gas, be aware that hydrogen gas can flow into the oven and create an explosion hazard. Therefore, be sure that the supply is off until all connections are made and ensure that the inlet and detector column fittings are either connected to a column or capped at all times when hydrogen gas is supplied to the instrument.

Warning Hydrogen is flammable. Leaks, when confined in an enclosed space, may create a fire or explosion hazard. In any application using hydrogen, leak test all connections, lines, and valves before operating the instrument. Always turn off the hydrogen supply at its source before working on the instrument.

Inlet and column controls

The inlet and column controls are related, and the relationship depends on whether or not the column is configured. Set up the GC as described below.

1. If you are using a packed column, or an unconfigured wide-bore capillary column, only the flow modes are available. This is the default control method for the purged packed inlet.

If you are using a wide-bore capillary column, you can configure the column (see [Configuring the column](#) on page 38) and use column and inlet pressure modes instead of flow modes.

2. Select the column mode (see [Column modes](#) on page 40).
3. Program column flow or pressure, if desired (see [Flow or pressure programming](#) on page 44).
4. Set up the inlet (see [Inlet Setup](#) on page 80).
5. Set up the oven (see [Oven setup](#) on page 149).
6. Set up the detector (see [Thermal Conductivity Detector](#) on page 125, [Flame Ionization Detector](#) on page 134; [The Flame Photometric Detector \(FPD\)](#) on page 157, or [The Microcell Electron Capture Detector](#) on page 144).

Inlet Setup

To set up the inlet, display the following screen.

Status / Setup / Inlet Setup

Inlet Setup		12:31:40	Cur Sample 01	Default+	Not Ready
Carrier Gas	Units	Adjustments			
<input checked="" type="radio"/> He <input type="radio"/> H2 <input type="radio"/> N2	<input checked="" type="radio"/> psi <input type="radio"/> kPa <input type="radio"/> bar	<input checked="" type="radio"/> none <input type="radio"/> Vacuum Correct <input type="radio"/> Pressure Correct			
		<input type="text" value="0.00"/> psi			
<input type="text"/>	<input type="text"/>	<input type="text"/>	<input type="text"/>	<input type="text"/>	<input type="text"/>

1. Select the carrier gas you will use.
2. Select the pressure units you prefer (see [Table 13](#) for conversions).

Table 13. Pressure Unit Conversions

To convert	To	Multiply by
psi	bar	0.0689476
	kPa	6.89476
bar	psi	14.5038
	kPa	100
kPa	psi	0.145038
	bar	0.01

3. Select pressure adjustments, if needed.
 - **Vacuum Correct**, if the column empties into a vacuum. For example, you may be using a Mass Selective Detector or mass spectrometer.
 - **none**, if pressure is normal. This setting is the case for most detectors.
 - **Pressure Correct**, if another condition is involved.

Using a purged packed inlet

This inlet is used with packed columns when high-efficiency separations are not required. It can also be used with wide-bore capillary columns, provided that flows greater than 10 mL/min are acceptable.

If a capillary column is used and the column is configured, the inlet is pressure-controlled. If the column is **not** configured (packed columns and unconfigured capillary columns), the inlet is flow-controlled.

Figure 7 compares these modes.

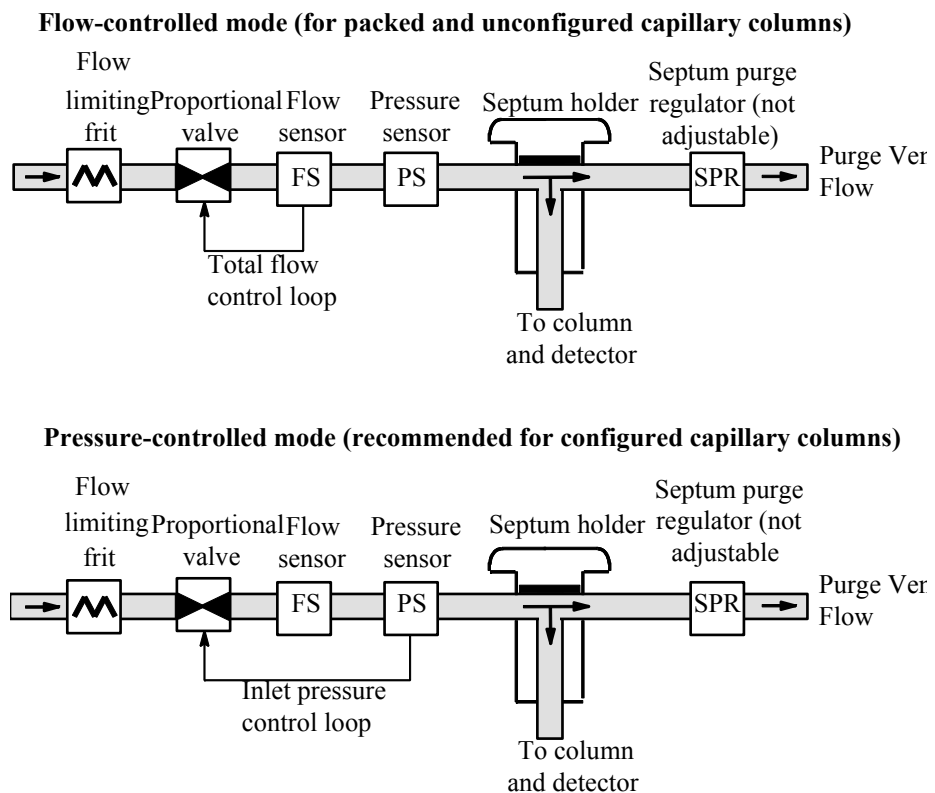
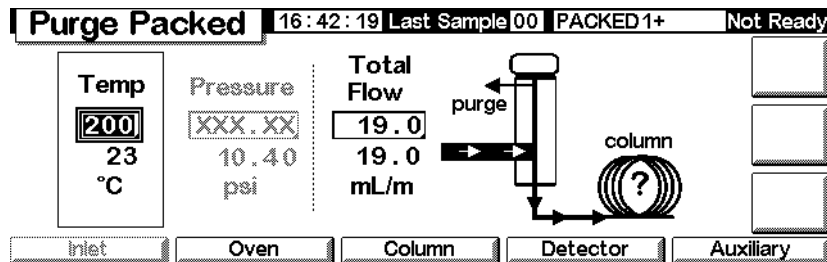

Figure 7. Purged packed inlet flow diagram

Packed column or undefined capillary column

To program the inlet when using a packed column or an unconfigured capillary column, display this screen.

Status / Settings / Inlet



In the example above, notice that:

- Setpoint and actual temperatures and flows are displayed
 - The inlet pressure is measured and displayed for your reference
1. Set the inlet temperature.
 2. Set the total flow rate through the inlet. The total flow is the column flow rate plus the septum purge flow rate.

With configured capillary columns

To program the inlet when using a configured capillary column:

1. Display this screen.

Status / Settings / Inlet

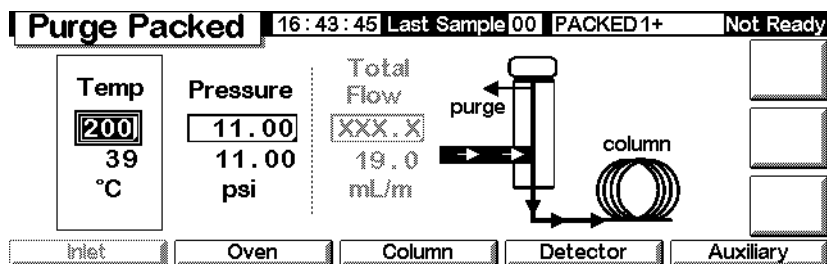

2. Set the inlet temperature and pressure for the method.
 - Setpoint and actual temperatures and pressures are displayed.
 - The total flow rate is measured and displayed for your reference.

The Programmable Temperature Vaporization Inlet

Using hydrogen

Warning When using hydrogen (H₂) as a carrier gas or fuel gas, be aware that hydrogen gas can flow into the oven and create an explosion hazard. Therefore, be sure that the supply is off until all connections are made and ensure that the inlet and detector column fittings are either connected to a column or capped at all times when hydrogen gas is supplied to the instrument.

Warning Hydrogen is flammable. Leaks, when confined in an enclosed space, may create a fire or explosion hazard. In any application using hydrogen, leak test all connections, lines, and valves before operating the instrument. Always turn off the hydrogen supply at its source before working on the instrument.

Inlet modes

The Agilent Programmed Temperature Vaporization (PTV) Inlet System has five operating modes:

- The *split mode* is generally used for major component analyses.
- The *pulsed split mode* is like the split mode, but with a pressure pulse applied to the inlet during sample introduction to speed the transfer of material to the column.
- The *splitless mode* is used for trace analyses.
- The *pulsed splitless mode* allows for a pressure pulse during sample introduction.
- The *solvent vent mode* is used for large volume injection. Either single or multiple injections can be made for each run.

Inlet and column

The inlet and column controls are related, and the relationship depends on whether or not the column is configured. We strongly recommend that you set up the GC in this order:

1. Configure the column (see [Configuring the instrument](#) on page 12). If you do not, only the pressure modes of the column and inlet can be used. The flow-dependent features of the inlet, such as setting a split ratio directly, are not available.
2. Select the column mode (see [Column modes](#) on page 40).
3. Program column flow or pressure, if desired (see [Flow or pressure programming](#) on page 44).
4. Set up the inlet (see [Inlet setup](#) on page 84).
5. Set up the oven ([Oven setup](#) on page 149) and detector (see the appropriate chapter.).

Inlet setup

To configure the inlet, display the following screen.

Status / Setup / Inlet Setup

Inlet Setup		11:31:48	Last Sample 00	Service Mode+	Not Ready
Carrier Gas		Units		Adjustments	
<input checked="" type="radio"/> He	<input checked="" type="radio"/> psi	<input checked="" type="radio"/> none			
<input type="radio"/> H2	<input type="radio"/> kPa	<input type="radio"/> Vacuum Correct			
<input type="radio"/> N2	<input type="radio"/> bar	<input type="radio"/> Pressure Correct		0.00	
				psi	
					

1. Select the carrier gas you will use.
2. Select the pressure units you prefer (see [Table 14](#) for conversions.)

Table 14. Pressure Unit Conversions

To convert	To	Multiply by
psi	bar	0.0689476
	kPa	6.89476
bar	psi	14.5038
	kPa	100
kPa	psi	0.145038
	bar	0.01

3. Select pressure adjustments, if needed.
 - Vacuum Correct, if the column empties into a vacuum. For example, you may be using a Mass Selective Detector or mass spectrometer.
 - none, if pressure is normal. This setting is the case for most detectors.
 - Pressure Correct, if another condition is involved.
4. Press More, select Coolant Type and press Enter.

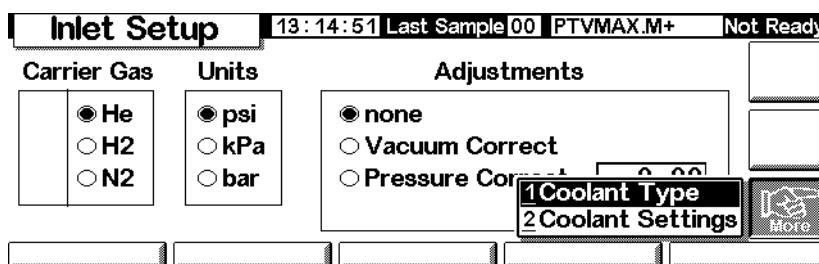

5. Set the type of coolant and press OK. To disable inlet cryo cooling or if no cryo cooling is available, select No Coolant. Press OK.

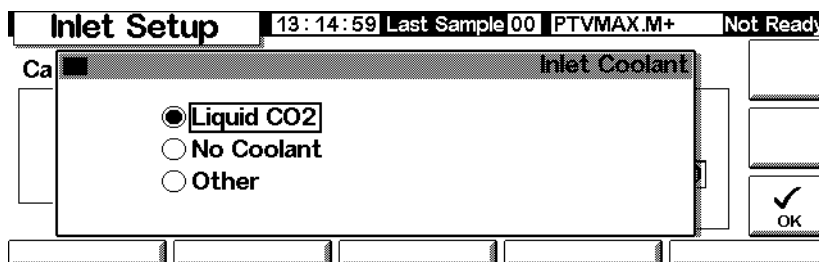

- If you selected Liquid CO₂, press More, and select Coolant Settings. The following screen appears. Enter information as applicable and press OK.

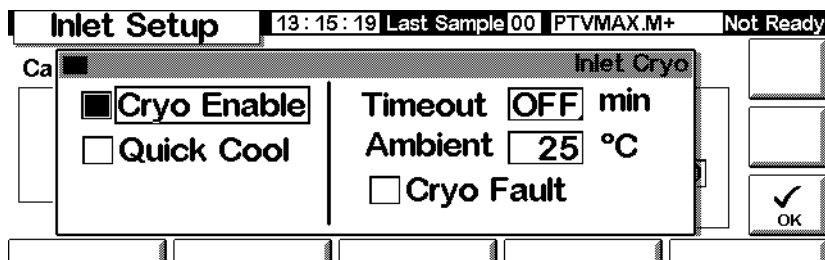

- Cryo Enable**—When selected, this enables cryogenic cooling of the inlet as soon as the column oven reaches its initial temperature. Unselected disables cooling.
- Timeout**—Cryo timeout occurs, and the inlet temperature shuts down, when a run does not start within this specified time (range 5 to 120 minutes, default 30 minutes) after the oven equilibrates. Turning cryo timeout off disables this feature. We recommend that it be turned on because cryo timeout conserves coolant at the end of a sequence or if automation fails. A Post Sequence method could also be used.
- Ambient**—If **Cryo** is enabled, this is the upper limit of temperatures at which cryo cooling is used to hold the inlet at its setpoint. If the setpoint is higher than this limit, cryogenic cooling is used to bring the inlet down to its setpoint but is not used to hold it at the setpoint.
- Cryo Fault**—Select to enable shut down of the inlet if it does not reach setpoint in 16 minutes of continuous cryo operation. Note that this is the time to *reach* the setpoint, not the time to stabilize and become ready at the setpoint.

Shutdown behavior

Both Cryo timeouts and Cryo faults can cause cryo shutdown. Cryo shutdowns conserve coolant when the GC is unable to start a run. The cryogenic cooling system may still be working properly. A cryo timeout occurs if your specified cryo timeout period expires before the oven reaches its temperature setpoint. A cryo fault occurs if cryo cooling has been on for over 16 minutes but the oven has not reached its temperature setpoint. If this happens, the inlet heater is turned off and the cryo valve closes. The GC beeps and displays `Inlet cryo shut off`.

The inlet heater is monitored to avoid overheating. If the heater remains on for over the allowed duration and the inlet is not at setpoint, the heater is shut down. The GC beeps and displays `Inlet heating slow`.

To recover from either condition, turn the GC off, then on, or enter a new setpoint.

Setting the inlet mode

Before you do programming, set the inlet mode you want. To do so:

1. Display this screen. The example below shows an inlet in `Splitless` mode.

Status / Settings / Inlet / More / Inlet Mode / Enter

PTV Inlet		13:18:06	Last Sample 01	4+	Not Ready
PTV Inlet Mode					
Mode <input type="radio"/> Split <input checked="" type="radio"/> Splitless <input type="radio"/> Solvent Vent	Vent Settings Pressure <input type="text" value="6.00"/> psi Flow <input type="text" value="0.00"/> ml/min Vent End <input type="text" value="5.00"/> min	Purge Flow Flow <input type="text" value="0.00"/> mL/min Purge Start <input type="text" value="0.00"/> min			
					<input checked="" type="checkbox"/> OK

2. Select the mode you prefer and press OK to return to the previous screen.

Heating the inlet

Temperature can be programmed with an initial temperature and up to 3 rates and plateaus. Rates between 0.1 and 720°C/min can be selected.

Caution If the initial inlet temperature and the oven initial temperature are too close, the inlet may be unable to maintain its setpoint. We recommend a difference of at least 6°C, either higher or lower.

For most purposes, the PTV is designed to hold the sample in the inlet liner until the entire sample—there could be several injections—has been injected. Then the PTV is heated rapidly to transfer the sample to the column. This can be accomplished with an initial hold, a single ramp, and a hold at the end to complete sample transfer.

Two additional ramps are available and have several possible uses:

- The inlet can be heated to a high temperature to thermally clean the liner for the next run.
- The inlet can be programmed downward—just set the Final temp below the previous temperature—to reduce thermal stress on the inlet.
- Downward programming can be used to prepare the inlet for the next run. This can reduce cycle time for greater sample throughput.

To program a PTV temperature ramp:

1. Display this screen.

Status/Settings/Inlet/Ramps/Ramp 1

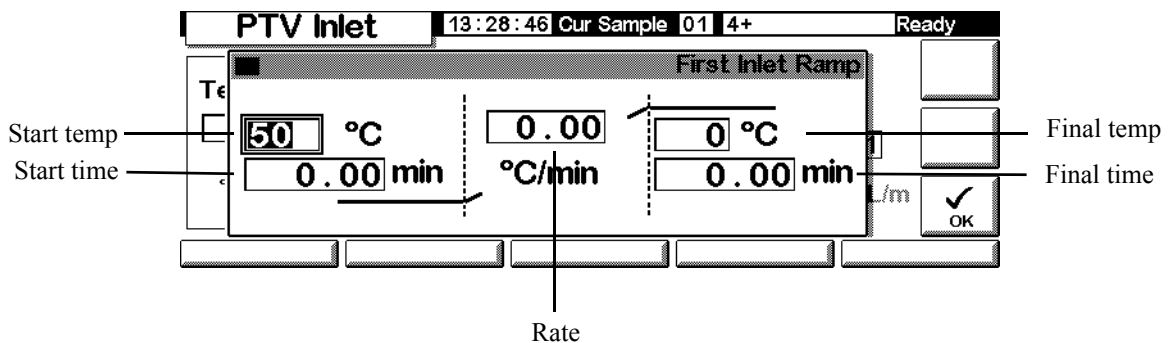

- *Start temp*—Actual and setpoint inlet temperatures.
 - *Start time*—The time, measured from Start Run, when the initial inlet temperature hold ends. Usually later than Vent End.
 - *Rate*—Temperature program rate for inlet thermal ramps 1, 2, and 3. The maximum is 720°C per minute.
 - *Final temp*—Final inlet temperature for ramps 1, 2, and 3. The range is --30°C to 375°C, and is a duration, not a measurement from Start Run.
 - *Final time*—Hold time at Final temp 1, 2, and 3.
2. Enter the ramp. This is similar to [Temperature programming](#) on page 151.

PTV terms

Following are terms used in relation to the PTV inlet. Many are fields on screens that you see when using this inlet.

- *Flow*—The flow, in mL/min, from the purge vent, at `Purge Start`. You will not be able to specify this value if operating with your *column not configured*.
- *Pressure*—Actual and setpoint inlet pressure before and after the pressure pulse or vent period (measured in psi, bar, or kPa). This is the starting point of a pressure program, column head or the fixed pressure if a program is not used.
- *Pulse pressure*—The inlet pressure you desire at the beginning of a run. The pressure rises to this setpoint after `Prep Run` is pressed and remains constant until `Pulse time` elapses, when it returns to `Pressure`.
- *Pulse time*—Inlet pressure returns to its normal setpoint at this time after `Start Run`.
- *Purge flow*—The flow of carrier gas, in mL/min, from the purge vent, at `Purge Start`. The column must be configured.
- *Purge start*—The time, measured from `Start Run`, when sample transfer ends (purge valve opens). Set purge start 0.1 to 0.5 minutes before pulse time.
- *Split flow*—Flow, in mL/min from the split/purge vent. This field is not available if your column is not configured.
- *Split ratio*—The ratio of split flow to column flow. This field is not available if your column is not configured.
- *Temp*—Actual and setpoint initial inlet temperatures.
- *Total flow*—The total flow into the inlet, the sum of the split flow, column flow, and septum purge flow, displayed during a Pre-run (Pre-run light is on and *not* blinking) and during a run before `Purge Start`. You cannot enter a setpoint at these times. At all other times, `Total flow` will have both setpoint and actual values. When you change total flow, the split ratio and split flow change while column flow and pressure remain the same. When a pressure pulse is used, total flow increases to keep the split ratio constant.
- *Vent End*—The time, measured from `Start Run`, when solvent venting ends. For large volume injections, this time is normally later than the time for the injection to complete.

- *Vent flow*—The flow of carrier gas out the split vent during the vent period. Higher flows sweep the liner more quickly and reduce the time for solvent elimination. For most columns, 100 mL/min vent flow eliminates solvent at an acceptable rate but puts minimal material on the column.
- *Vent pressure*—The inlet pressure during the vent period. By decreasing the inlet pressure while venting, solvent elimination proceeds faster. Also, the pressure reduction decreases the amount of carrier gas—and solvent vapor—that enters the column during this time.

Users select from 0 to 100 psig. If 0 is chosen, the inlet uses the lowest pressure possible at the given vent flow. [Table 15](#) shows approximate values for this minimum at various vent flows of helium. Pressures less than those in the table are not possible unless the flow is reduced.

Table 15. Minimum attainable pressures

Vent flow (mL/min)	Actual vent pressure at “0”psig setpoint	Actual vent pressure at “0” kPa setpoint
50	0.7	5
100	1.3	10
200	2.6	18
500	6.4	44
1000	12.7	88

Pulsed modes

The pressure pulse modes (split and splitless) increase inlet pressure just before the beginning of a run and return it to the normal value after a specified amount of time. The pressure pulse sweeps the sample out of the inlet and into the column faster, reducing the chance for sample decomposition in the inlet. If your chromatography is degraded by the pressure pulse, a retention gap may help restore peak shape.

You must press `Prep Run` before doing manual injections in a pressure pulse mode.

You can do column pressure and flow programming when in the pressure pulse mode. However, the pressure pulse will take precedence over the column pressure or flow ramp. See [Figure 8](#).

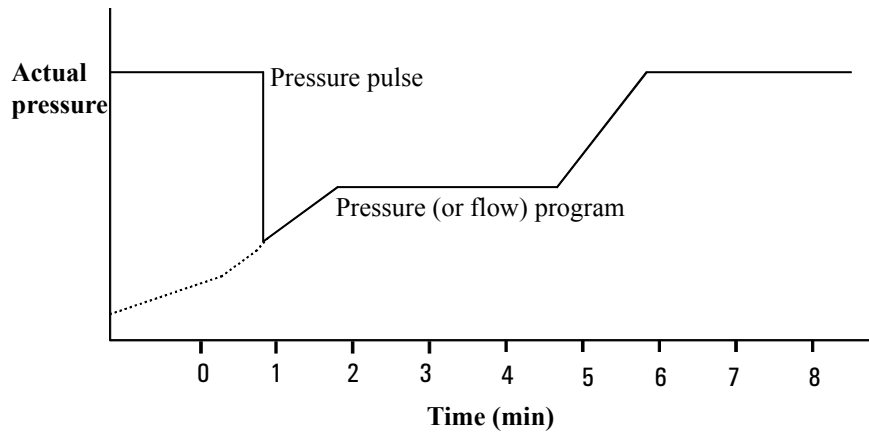
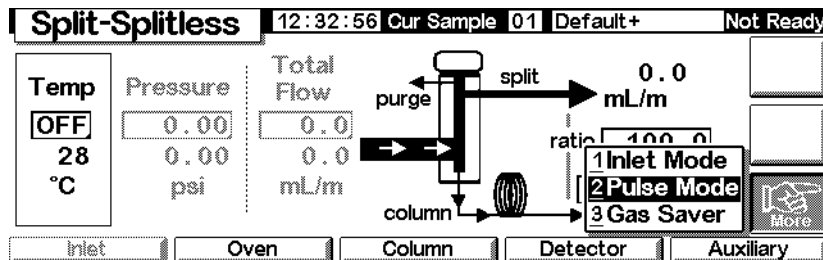

Figure 8. Pressure pulse and column flow or pressure

To set up a pressure pulse

1. Set up the flow conditions through the column, including a flow or pressure program (see [Flow or pressure programming](#) on page 44) if desired. Then display this screen.

Status / Settings / Inlet / More



2. Select Pulse Mode and press Enter to display the next screen.

Status / Settings / More / Pulse Mode / Enter

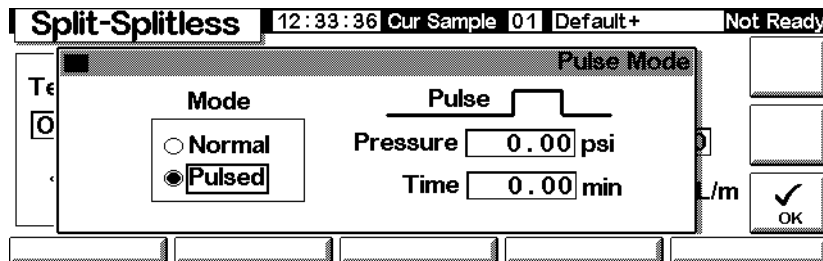

3. Select Pulsed. Enter values for Pressure and Time.
 - *Pressure*—the inlet pressure from Prep Run to Pulse Time.
 - *Time* (minutes after Start)—the time when the inlet pressure changes from Pulse Pressure to the pressure called for by the flow or pressure program (see [Flow or pressure programming](#) on page 44).
4. Press OK to accept these values or Esc to cancel.

To use pulsed splitless mode with the column configured

1. Verify that the:
 - column is configured (see [Navigating the screens](#) on page 8 and [Configuring the column](#) on page 38)
 - carrier gas is configured (see [Inlet setup](#) on page 84)
 - flow or pressure program, if used, is configured (see [Flow or pressure programming](#) on page 44)
2. Display this screen.

Status / Settings / Inlet

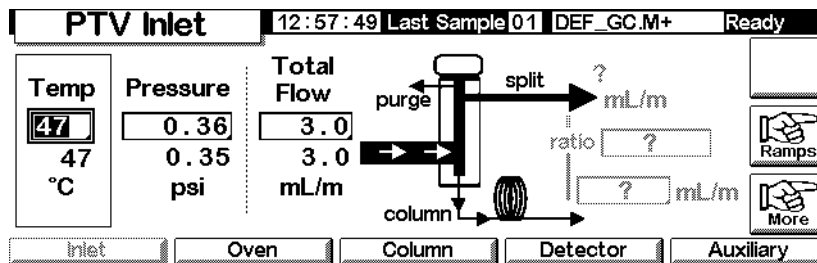

3. Set the inlet temperature and any desired ramps.
4. Press More and select Pulse Mode.
5. Select Pulsed Mode.

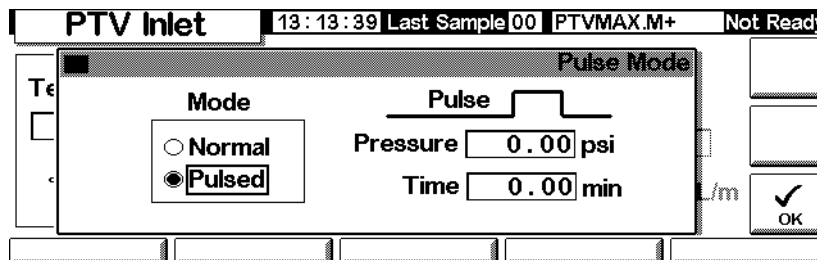

6. Enter values for Pulse Pressure and Pulse time and press OK.
7. Press More and select Inlet Mode.

8. Select Splitless.

9. Enter the Purge Start when you wish the purge valve to open.
10. Enter a Purge flow. Press OK.
11. Turn Gas saver on, if desired. Set the time *after* the Purge Start and press OK.

12. Press Prep Run (see page 68) before manually injecting a sample.

To use pulsed splitless mode with the column not configured

1. Verify that the:
 - column is configured (see [Navigating the screens](#) on page 8 and [Configuring the column](#) on page 38)
 - carrier gas is configured (see [Inlet setup](#) on page 84)
 - flow or pressure program, if used, is configured (see [Flow or pressure programming](#) on page 44)

2. Display this screen.

Status / Settings / Inlet

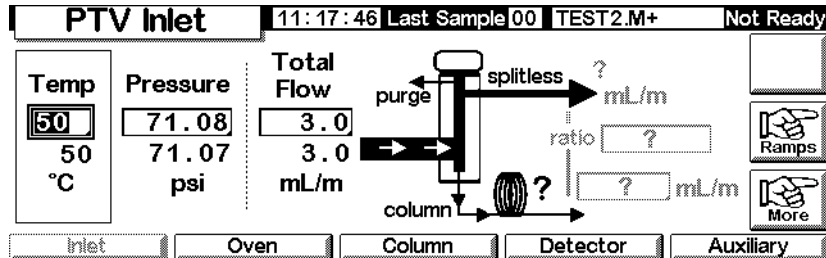

3. Set the inlet temperature and any desired ramps.
4. Press More and select Pulse Mode.
5. Select Pulsed for the Mode.

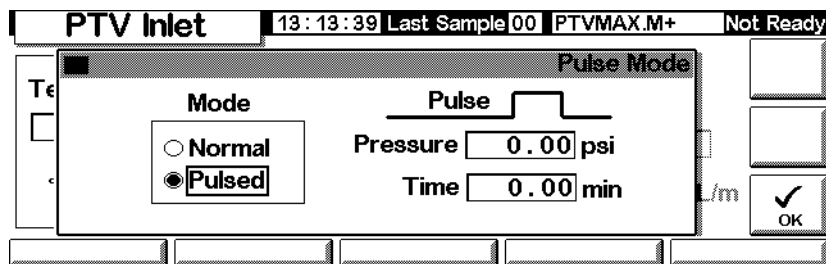

6. Enter values for Pulse pressure and Pulse time and press OK.
7. Press More and select Inlet Mode.
8. Enter the Purge Start when you wish the purge valve to open.

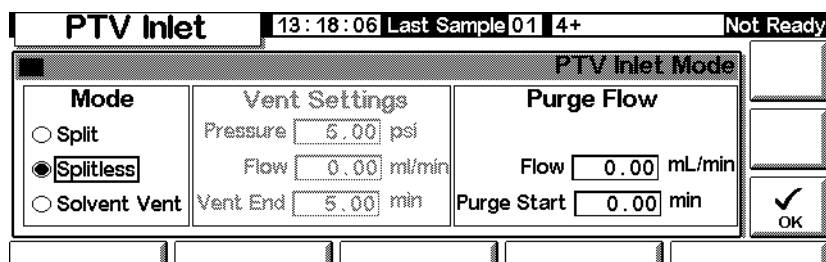

9. Press OK.
10. Press Prep Run (see page 68) before manually injecting a sample.

To use pulsed split mode with the column configured

1. Verify that the:
 - column is configured (see [Navigating the screens](#) on page 8 and [Configuring the column](#) on page 38)
 - carrier gas is configured (see [Inlet setup](#) on page 84)
 - flow or pressure program, if used, is configured (see [Flow or pressure programming](#) on page 44)
 - inlet is in pulsed split mode (see [Setting the inlet mode](#) on page 87 and [To set up a pressure pulse](#) on page 91)
2. Display this screen. It may appear differently (certain fields may or may not be editable), depending on how the column is configured.

Status / Settings / Inlet

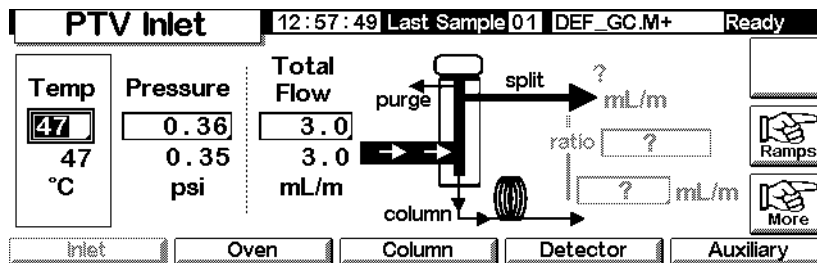

3. Set Temperature. Set column mL/min. Then enter the Ratio or, if you prefer, the split mL/min. In either case, the instrument calculates and displays the other value.
4. Turn on the gas saver, if desired, by pressing More and choosing Gas Saver. Set the Saver time later than Pulse time. Press OK.

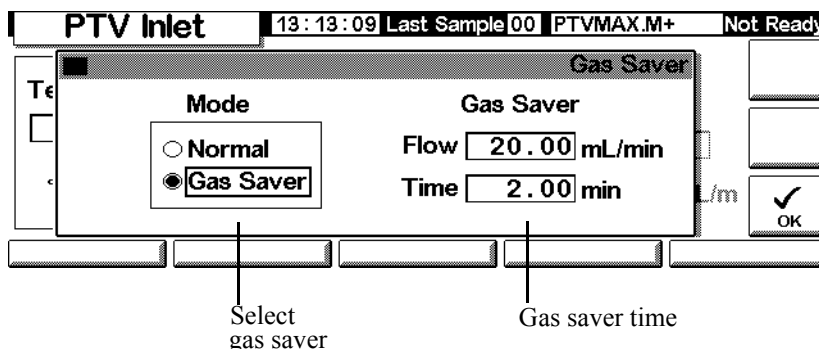

5. Press Prep Run (see page 68) before injecting a sample manually.

To use pulsed split mode with the column not configured

1. Verify that the:
 - column is configured (see [Navigating the screens](#) on page 8 and [Configuring the column](#) on page 38)
 - carrier gas is configured (see [Inlet setup](#) on page 84)
 - flow or pressure program, if used, is configured (see [Flow or pressure programming](#) on page 44)
 - inlet is in pulsed split mode (see [Setting the inlet mode](#) on page 87 and [To set up a pressure pulse](#) on page 91)
2. Display this screen.

Status / Settings / Inlet

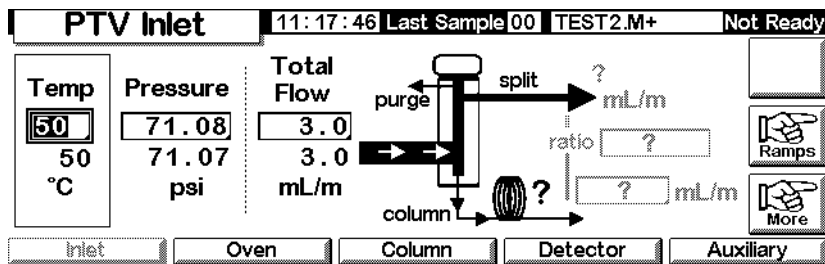

3. Set the inlet temperature and any desired ramps.
4. Press More and select Pulse Mode.
5. Select Pulsed Mode.

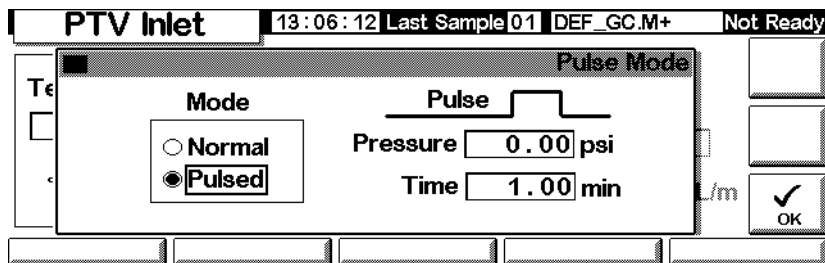

6. Enter values for Pulse Pressure and Pulse time and press OK.
7. Set the total flow into the inlet. Measure flows out of the split vent and septum purge vent using a flow meter.
8. Subtract the septum purge flow from the total flow.
9. Calculate the split ratio. Adjust as needed.

Split mode

The two split modes—with or without a pressure pulse—divide the gas stream entering the inlet between the column flow, the *split vent flow* (flow, in mL/min, from the split/purge vent) through the solenoid valve, and the septum purge flow. The ratio of the split vent flow to the column flow is called the *split ratio*.

The graphic below shows the flows with the septum head. Flows with the septumless head are the same except that the septum purge flow bypasses the head (lower left).

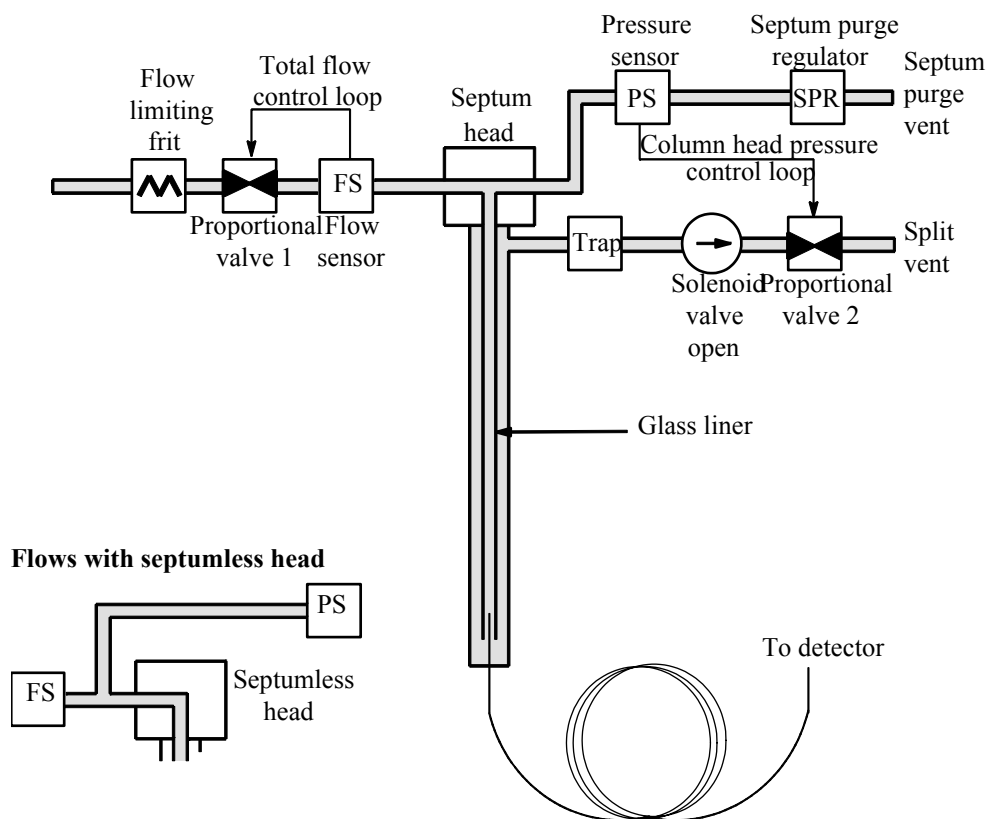

The *total flow* is the sum of the split flow, column flow, and septum purge flow. When you change the total flow, the split ratio and split flow change while the column flow and pressure remain the same.

Temperature considerations

Cold split introduction

For cold split sample introduction, use an initial inlet temperature below the normal

boiling point of the solvent. If the liner volume is enough to hold all the vaporized solvent, start the first inlet temperature ramp at 0.1 minutes with a high heating rate (500°C/min or higher). The final temperature should be high enough to volatilize the heaviest analytes from the liner and should be held for at least 5 minutes. A final temperature of 350°C for 5 minutes has proven sufficient to quantitatively transfer C₄₄.

For larger injection volumes or to eliminate the solvent, hold the initial temperature long enough to vent the solvent through the Split vent and then begin the first ramp. Use a fast rate for thermally stable analytes. Slower rates may help minimize thermal degradation in the inlet.

A single temperature ramp is enough for the injection process. The remaining ramps may be used to clean the liner or to reduce the inlet temperature in preparation for the next injection.

Hot split introduction

For hot split introduction, set an initial temperature high enough to volatilize the analytes. No additional thermal parameters are required as the inlet will maintain the set-point throughout the run.

Because of the small liner volume (about 120 microliters), the PTV has a limited injection capacity with hot split introduction. Injection volumes exceeding 1 µL in the hot split mode may overflow the inlet causing analytical problems. Cold split introduction avoids this potential problem.

To use split mode with the column configured

1. Verify that the:
 - column is configured (see [Navigating the screens](#) on page 8 and [Configuring the column](#) on page 38)
 - carrier gas is configured (see [Inlet setup](#) on page 84)
 - flow or pressure program, if used, is configured (see [Flow or pressure programming](#) on page 44)
 - inlet is in split mode (see [Setting the inlet mode](#) on page 87)

2. Display this screen. It may appear different (certain fields may or may not be editable), depending on the mode the column is in.

Status / Settings / Inlet

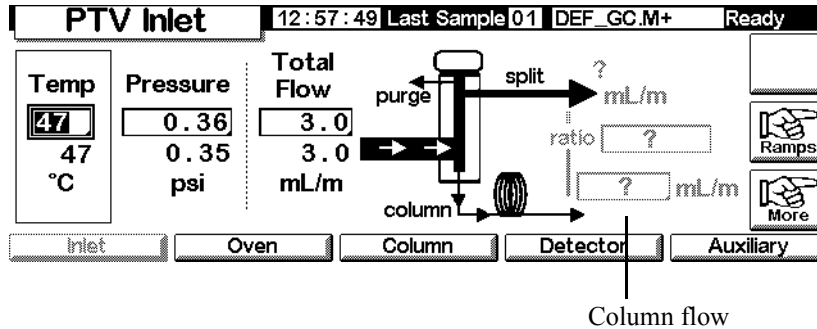

3. Set Temp, the initial inlet setpoint.
4. Enter the initial pressure or total flow.
5. Enter the desired split ratio or column flow.
6. If desired, turn on the Gas Saver by pressing More and selecting Gas Saver. Then, enter values for the parameters on the following screen and press OK.

Status / Settings / Inlet / More / Gas Saver

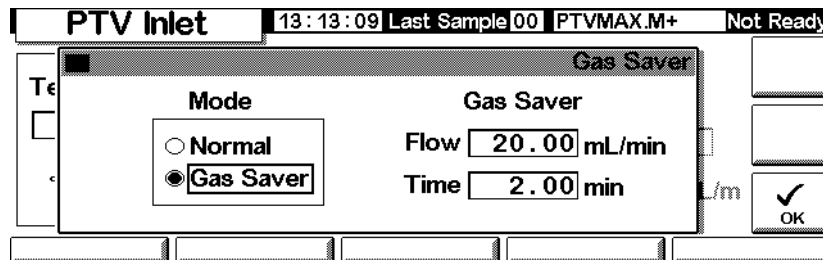

7. Press Prep Run before manually injecting the sample if the Gas Saver is on (see page 68).

To use split mode with the column not configured

1. Verify that the:
 - column is configured (see [Navigating the screens](#) on page 8 and [Configuring the column](#) on page 38)
 - carrier gas is configured (see [Inlet setup](#) on page 84)
 - flow or pressure program, if used, is configured (see [Flow or pressure programming](#) on page 44)
 - inlet is in split mode (see [Setting the inlet mode](#) on page 87)
2. Display this screen.

Status / Settings / Inlet

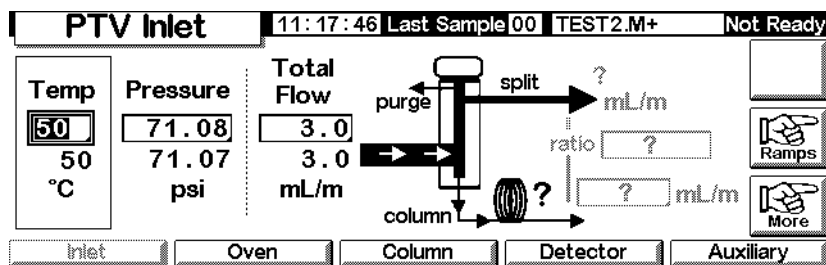

3. Set the inlet temperature.
4. Set total flow or pressure into the inlet. Measure flows out of the split vent and septum purge vent using a flow meter.
5. Subtract the septum purge flow from Total flow to get split flow.
6. Calculate the split ratio. Adjust as needed.

See [Figure 3](#) for a graphic of the pressure pulse and column flow or pressure.

Splitless mode

Flow pattern

In these modes—with or without a pressure pulse—the solenoid valve is closed during injection and vaporization of the sample and stays so while the sample transfers to the column (see [Figure 9](#)). At a specified time after injection, the valve opens to sweep vapors left in the liner out the split vent (see [Figure 10](#)). This avoids solvent tailing due to the large inlet volume and small column flow rate.

[Figure 9](#) shows the flows with the septum head. Flows with the septumless head are the same except that the septum purge flow bypasses the head (lower left).

[Figure 11](#) graphs flow, pressure, and temperature over time during this process.

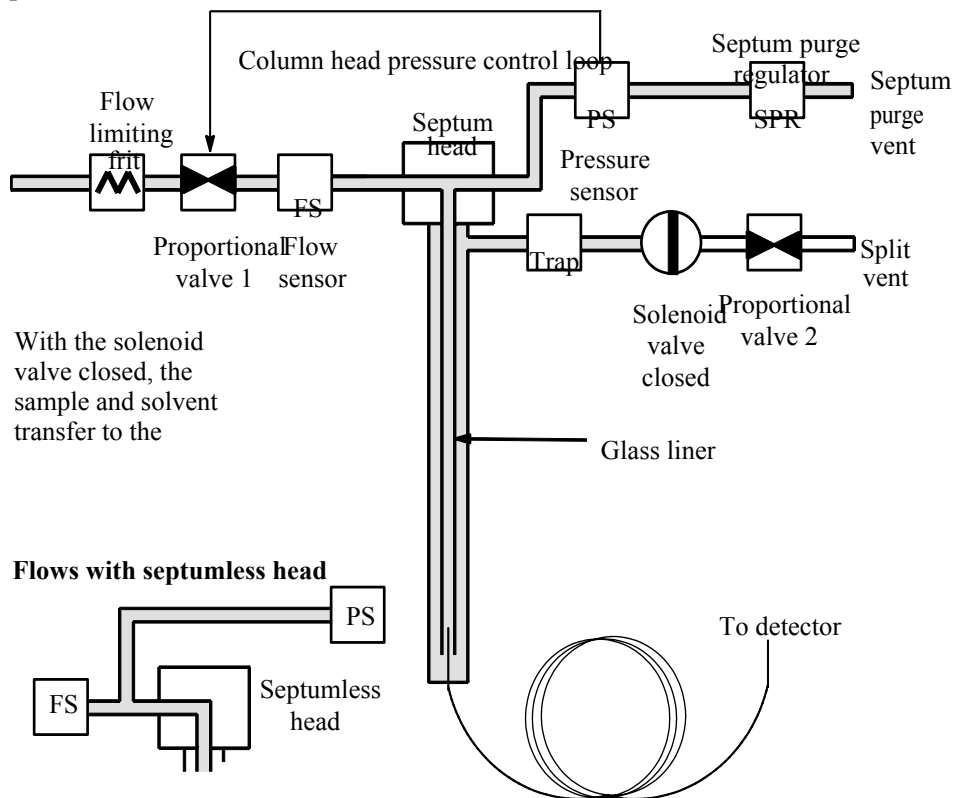

Figure 9. Stage 1. Sample injection

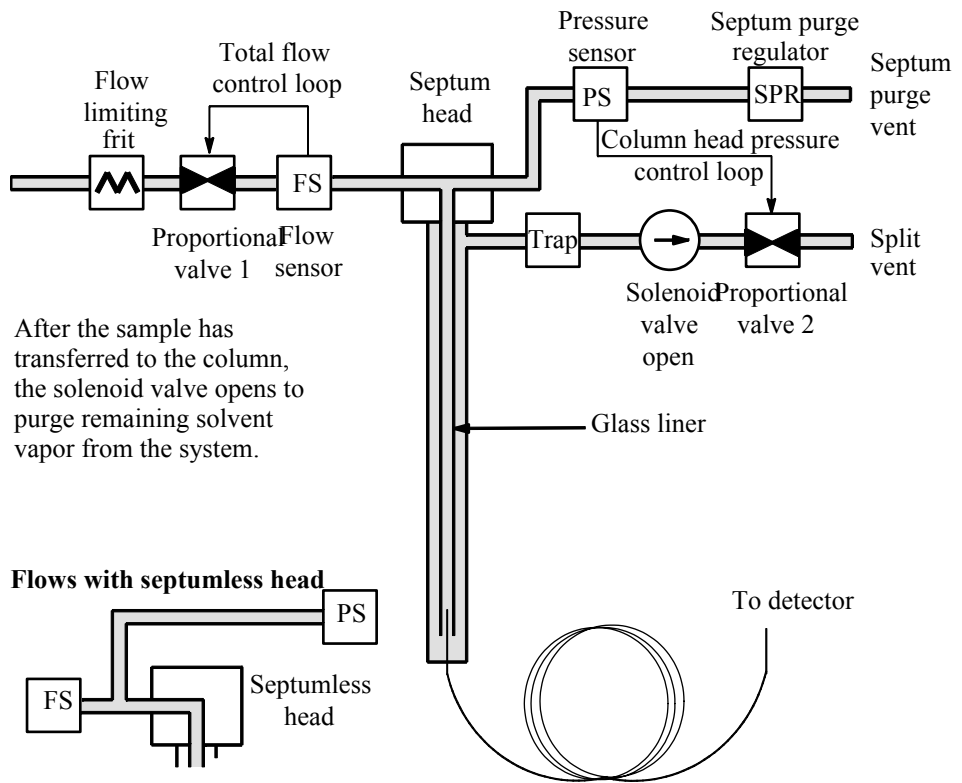

Figure 10. Stage 2. Purging

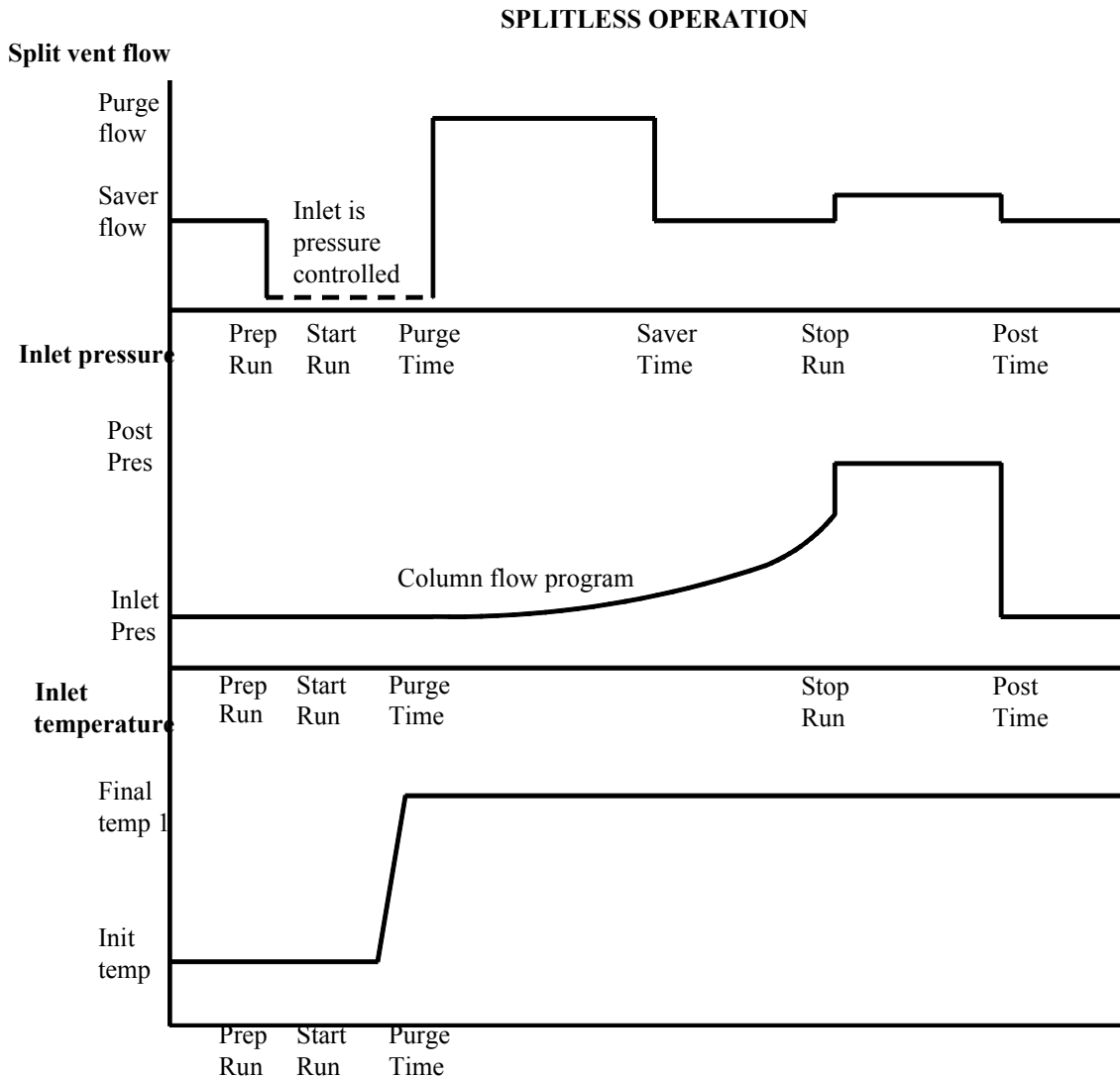

Figure 11. Flows, pressures, and temperatures

Temperature considerations

Cold splitless introduction

For cold splitless introduction, use an initial inlet temperature below the normal boiling point of the solvent. For most solvents, starting the first inlet temperature ramp at 0.1 minutes provides good transfer and reproducibility. A program rate of 500°C/min or higher is appropriate for thermally stable analytes. A final temperature of 350°C, held for 5 minutes, has quantitatively transferred up to C₄₄ alkane.

A main advantage of temperature programmability is that the inlet can be heated gently to transfer delicate analytes. If the oven is initially low enough to refocus the analytes on the column, the inlet heating rate can be made slower (e.g., 120°C/min). This reduces thermal degradation from the inlet and can improve peak shape and quantitation.

For most applications of cold splitless, a single temperature ramp is enough. The remaining ramps can be used to clean the liner or to decrease the inlet temperature to prepare for the next injection.

Hot splitless introduction

For hot splitless introduction, select an initial temperature high enough to volatilize the analytes. No additional temperature parameters are required as the inlet will maintain the setpoint throughout the run.

Because of the small liner volume (about 120 μL), the PTV cannot contain vapor resulting from large liquid injection volumes. Injection volumes greater than 1 μL may overflow vapor from the inlet, causing analysis variations. Cold splitless introduction avoids this problem.

Starting values

A successful splitless injection consists of these steps:

1. Inject the sample and temperature program the inlet to vaporize it.
2. Use a low column flow and low oven temperature to create a solvent-saturated zone at the head of the column.
3. Use this zone to trap and reconcentrate the sample at the head of the column.
4. Wait until all, or at least most, of the sample has transferred to the column. Then discard the remaining vapor in the inlet—which is mostly solvent—by opening a purge valve. This eliminates the long solvent tail that this vapor would otherwise cause.
5. Raise the oven temperature to analyze the sample.

Some experimentation is needed to refine the operating conditions. [Table 16](#) provides starting values for the critical parameters.

Table 16. Splitless Mode Inlet Parameters

Parameter	Allowed setpoint range	Suggested starting value
Oven temperature	No cryo, ambient+10°C to 350°C CO ₂ cryo, -30°C to 350°C	10°C below solvent boiling point
Oven initial time	0 to 999.9 minutes	≥ Inlet purge start
Inlet purge start	0 to 999.9 minutes	$\frac{\text{Liner volume}^*}{\text{Column flow}}$
Gas saver time	0 to 999.9 minutes	After purge start
Gas saver flow	15 to 1000 mL/min	15 mL/min greater than maximum column flow
Inlet temperature	No cryo, oven temp + 10°C to 375°C CO ₂ cryo, -30°C to 350°C	10°C below solvent boiling point for 0.1 min, then ramp up

* Liner volume is about 120 µL

To use splitless mode with the column configured

- Verify that the:
 - column is configured (see [Navigating the screens](#) on page 8 and [Configuring the column](#) on page 38)
 - carrier gas is configured (see [Inlet setup](#) on page 84)
 - flow or pressure program, if used, is configured (see [Flow or pressure programming](#) on page 44)
- Display this screen. It will vary based on your current settings.

Status / Settings / Inlet

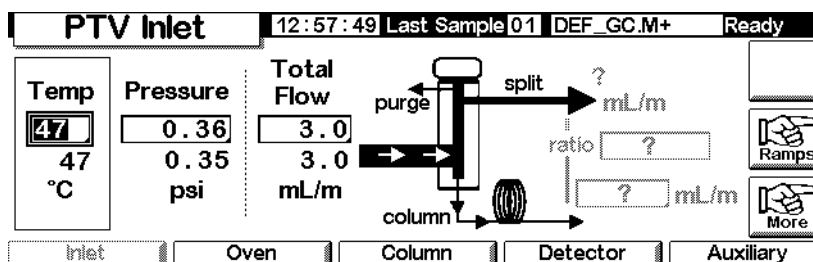

- Set the inlet temperature and any desired ramps.
- Enter column mL/min.
- Press More and select Inlet Mode.

6. Select Splitless.

The screenshot shows the 'PTV Inlet Mode' screen. At the top, it displays 'PTV Inlet', the time '13:18:06', 'Last Sample 01', '4+', and 'Not Ready'. The main area is divided into three sections: 'Mode', 'Vent Settings', and 'Purge Flow'. In the 'Mode' section, 'Splitless' is selected with a radio button. 'Vent Settings' shows 'Pressure' at 5.00 psi, 'Flow' at 0.00 mL/min, and 'Vent End' at 5.00 min. 'Purge Flow' shows 'Flow' at 0.00 mL/min and 'Purge Start' at 0.00 min. An 'OK' button with a checkmark is visible on the right side.

7. Enter a Flow and a Purge Start.

8. Press OK.

9. Turn on the gas saver, if desired, by pressing More and choosing Gas Saver. Set the Saver time later than the Purge Start.

The screenshot shows the 'Gas Saver' screen. At the top, it displays 'PTV Inlet', the time '13:13:09', 'Last Sample 00', 'PTVMAX.M+', and 'Not Ready'. The main area is divided into 'Mode' and 'Gas Saver' sections. In the 'Mode' section, 'Gas Saver' is selected with a radio button. The 'Gas Saver' section shows 'Flow' at 20.00 mL/min and 'Time' at 2.00 min. An 'OK' button with a checkmark is visible on the right side. Below the screen, two annotations with arrows point to the 'Gas Saver' radio button and the 'Time' field, labeled 'Select gas saver' and 'Gas saver time' respectively.

10. Press OK.

11. Press Prep Run (see page 68) before manually injecting a sample.

To use splitless mode with the column not configured

1. Verify that the:
 - column is configured (see [Navigating the screens](#) on page 8 and [Configuring the column](#) on page 38)
 - carrier gas is configured (see [Inlet setup](#) on page 84)
 - flow or pressure program, if used, is configured (see [Flow or pressure programming](#) on page 44)
 - inlet is in splitless mode (see [Setting the inlet mode](#) on page 87)

2. Display this screen It will vary depending on your current settings.

Status / Settings / Inlet

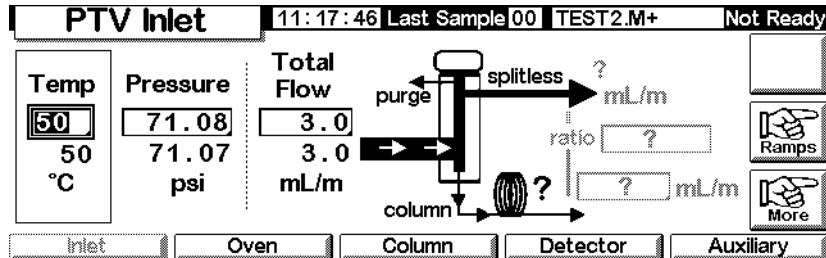

3. Set the inlet temperature and any desired ramps.
4. Press More and select Inlet Mode.
5. Select Splitless.

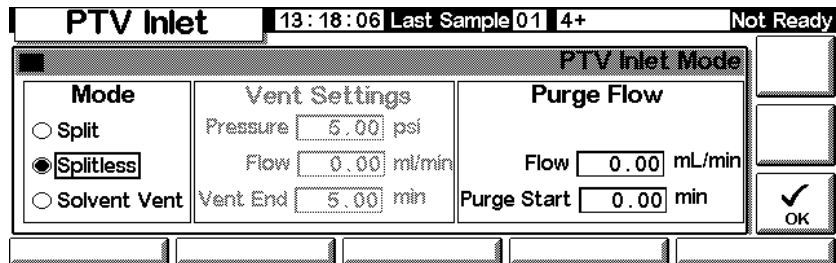

6. Enter a Purge Start and Flow. Press OK.
7. Press Prep Run (see page 68) before manually injecting a sample.

Solvent vent mode

Flow pattern

The sample is injected into a cold inlet. If conditions are properly chosen and the sample is suitable, analytes deposit in the inlet liner while the solvent evaporates and is swept out. Large or multiple injections can be used to concentrate sample in the inlet before transferring to the column for analysis.

The graphic below shows the flows with the septum head. Flows with the septumless head are the same except that the septum purge flow bypasses the head (lower left).

Stage 1. Sample and vent

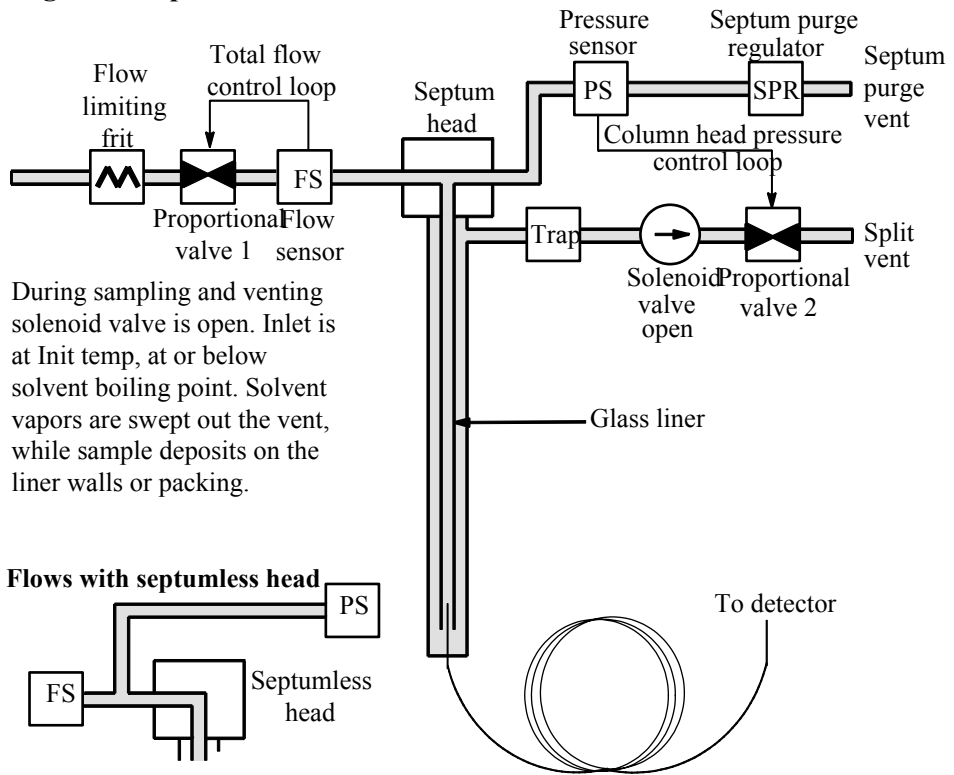

During sampling and venting solenoid valve is open. Inlet is at Init temp, at or below solvent boiling point. Solvent vapors are swept out the vent, while sample deposits on the liner walls or packing.

Stage 2. Sample transfer

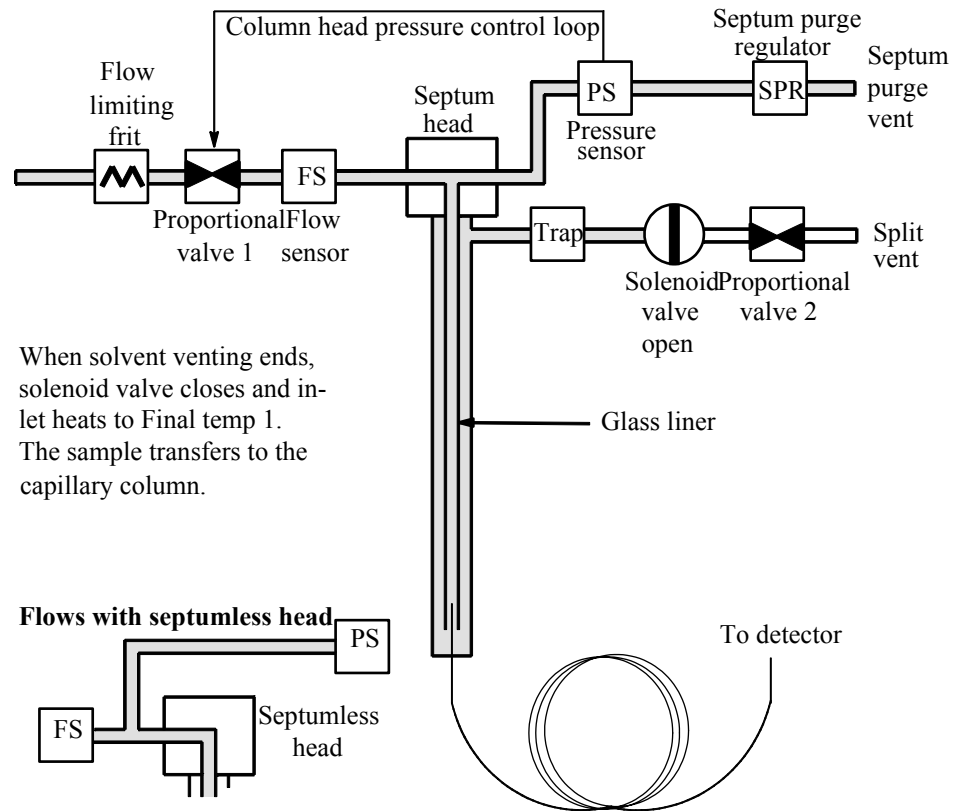

Stage 3. Purge and cleanup

The solenoid valve opens again and the system returns to the Stage 1 configuration but with different setpoints. The PTV inlet is flushed. Additional ramp rates are available to thermally clean the inlet or to reduce inlet temperature after sample transfer. This can extend the life of the liner.

Temperature, pressure, and flow considerations

The solvent vent mode goes through three distinct pneumatic states; venting, sample transfer, and purging. The vent portion allows the inlet pressure and the vent flow to be adjusted to optimize solvent elimination. The transfer state mimics traditional splitless operation and transports the analytes from the liner to the column. The purging mode allows the user to prepare the inlet for the next run.

A fundamental difficulty with solvent vent mode is the potential loss of volatile analytes with the solvent. Several solutions are possible for this situation:

- The inlet liner can be packed with a more retentive material, such as Tenax. This greatly improves volatile analyte recovery but may impact recovery of higher boiling materials.
- Some of the solvent can be left in the liner when sample transfer begins. The residual solvent acts like a stationary phase and retains volatile material, but at the expense of a larger solvent peak.
- The inlet temperature can be reduced. This reduces the vapor pressure of the volatile analytes and permits higher recoveries.

Solvent removal can be speeded up by:

- Reducing pressure in the inlet during sample introduction—the `Vent pressure` parameter
- Increasing flow through the inlet—the `Vent flow` parameter

While all these possibilities do complicate use of the PTV, they provide increased flexibility and new potential to solve difficult problems.

Sequence of operations

These are the steps in a typical analysis using the solvent vent mode.

Step	Parameter	Value
1	Before injection	Flow at split vent Inlet pressure
		Either Purge flow or Saver flow Derived from column setpoint
		The system is resting, with Purge flow (or Saver flow, if on) through the inlet.
2	Prep Run begins	Flow at split vent Inlet pressure
		Vent flow setpoint Vent pressure setpoint
		Setpoints change to prepare for injection. When GC is ready, the sample is injected. Inlet and oven temperature program Init times begin. Solvent venting and analyte trapping begin.
3	At Vent End	Flow at split vent Inlet pressure
		None, solenoid valve closed Column pressure setpoint
		Solvent venting ends, analyte transfer begins as inlet heats up.
4	At Purge Start	Flow at split vent Inlet pressure
		Purge flow setpoint Column pressure setpoint
		Analyte transfer ends, inlet is purged of residual vapor. Analysis begins.
5	At Saver time	Flow at split vent Inlet pressure
		Saver flow setpoint Column pressure setpoint
		Analysis ends, carrier flow reduced to save gas (if Saver is on).

Some important points

- The flow through the column is governed by the pressure in the inlet. This is controlled, during the analysis part of the process, by the flow or pressure setpoint or program entered *for the column*.
- Vent End and Purge Start must come *before* Saver time.
- Vent End must occur before the inlet starts to heat and release analytes.
- Purge Start must occur before the oven begins to heat and move sample through the column.

Time lines

Time increases downward; all other quantities increase to the right. [Table 12](#) diagrams this relationship.

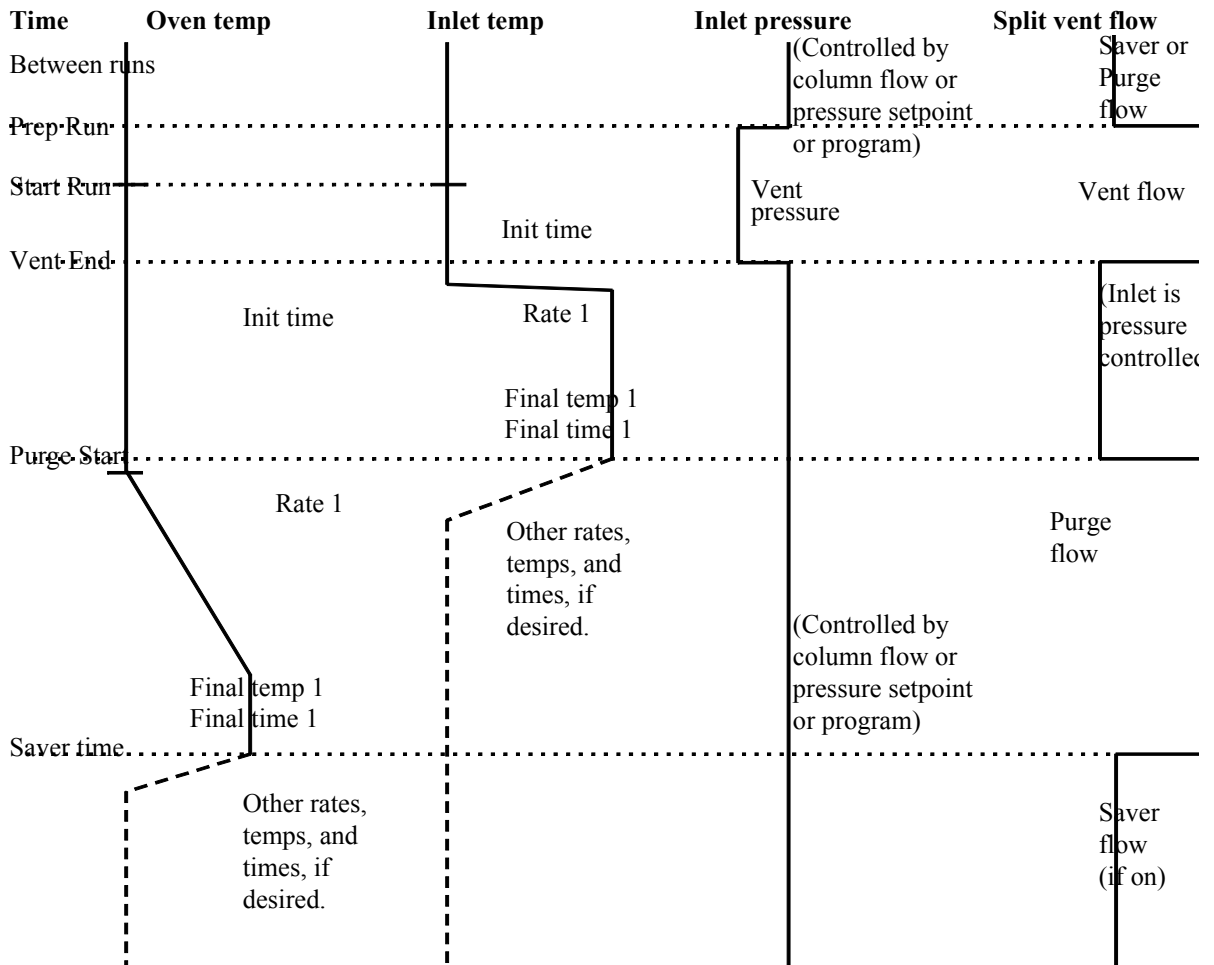

Figure 12. Time relationships

When is start run?

Both the inlet and oven temperature programs begin at Start Run. All times—such as Purge Start—are measured from Start Run. When does Start Run occur?

- If the sample is injected manually, Start Run occurs when the user presses the Start Run key.
- If a single injection per run is made using an autosampler, Start Run occurs when the syringe carrier moves down to make the injection.
- If multiple injections per run are made using an autosampler, Start Run occurs when the syringe carrier moves down to make the first injection of the set. There are no Start Runs for the rest of the injections in the set.

These additional injections take time. To allow for this, adjust the inlet and oven temperature programs (mainly the ramp Start Time values). Also, you must adjust the various time values that control the inlet operation. This is discussed in more detail under [Large volume injection](#) on page 115.

To use solvent vent mode with the column configured

1. Verify that the:
 - column is configured (see [Navigating the screens](#) on page 8 and [Configuring the column](#) on page 38)
 - carrier gas is configured (see [Inlet setup](#) on page 84)
 - flow or pressure program, if used, is configured (see [Flow or pressure programming](#) on page 44)
2. Display this screen. It will vary based on your current settings.

Status / Settings / Inlet

The screenshot displays the 'PTV Inlet' control interface. At the top, it shows the time '12:27:58', 'Last Sample 01', 'DEF_GC.M+', and 'Not Ready' status. The main area is divided into several sections:

- Temp:** A digital display shows '45' with '45 °C' below it.
- Pressure:** Two digital displays show '0.23' and '0.33' with 'psi' below them.
- Total Flow:** Two digital displays show '3.0' and '3.0' with 'mL/m' below them.
- Schematic Diagram:** A diagram of the inlet system with labels: 'purge', 'splitless', 'ratio', 'column', and '0.00 mL/m'.
- Buttons:** 'Ramps' and 'More' buttons are on the right side.
- Navigation Bar:** At the bottom, there are buttons for 'Inlet', 'Oven', 'Column', 'Detector', and 'Auxiliary'.

3. Press More. Select Inlet Mode.
 - a. Select Solvent vent for the Mode.

PTV Inlet			16:33:14	Last Sample 00	Default+	Not Ready
PTV Inlet Mode						
Mode		Vent Settings		Purge Flow		
<input type="radio"/> Split <input type="radio"/> Splitless <input checked="" type="radio"/> Solvent Vent		Pressure <input type="text" value="5.00"/> psi Flow <input type="text" value="100.00"/> ml/min Vent End <input type="text" value="0.50"/> min		Flow <input type="text" value="15.00"/> mL/min Purge Start <input type="text" value="5.00"/> min		
						OK

- b. Enter vent Pressure, Flow, and Vent End. Vent End should be set to a time earlier than any ramp's starting time.
- c. Enter Purge Start and Flow. Press OK.
- d. Set the inlet temperature and ramps, as desired.
- e. If desired, turn Gas saver on and press OK. Make certain the time is set *after* the Purge Start

PTV Inlet			13:13:09	Last Sample 00	PTVMAX.M+	Not Ready
Gas Saver						
Mode		Gas Saver				
<input type="radio"/> Normal <input checked="" type="radio"/> Gas Saver		Flow <input type="text" value="20.00"/> mL/min Time <input type="text" value="2.00"/> min				
						OK

4. Press Prep Run (see page 68) before manually injecting a sample.

To use solvent vent mode with the column not configured

1. Verify that the:
 - column is not configured (see [Navigating the screens](#) on page 8 and [Configuring the column](#) on page 38)
 - carrier gas is configured (see [Inlet setup](#) on page 84)
 - flow or pressure program, if used, is configured (see [Flow or pressure programming](#) on page 44)

2. Display this screen. It will vary based on your current settings.

Status / Settings / Inlet

PTV Inlet		11:17:46	Last Sample 00	TEST2.M+	Not Ready
Temp <input type="text" value="50"/> 50 °C	Pressure <input type="text" value="71.08"/> 71.07 psi	Total Flow <input type="text" value="3.0"/> 3.0 mL/m			<input type="text" value="?"/> mL/m ? <input type="text" value="?"/> mL/m ?
			<input type="text" value="?"/> ratio <input type="text" value="?"/> mL/m	<input type="button" value="Ramps"/>	
<input type="button" value="Inlet"/>	<input type="button" value="Oven"/>	<input type="button" value="Column"/>	<input type="button" value="Detector"/>	<input type="button" value="Auxiliary"/>	

3. Press More. Select Inlet Mode.
 - a. Select Solvent Vent for the Mode.

PTV Inlet		16:33:14	Last Sample 00	Default+	Not Ready
PTV Inlet Mode					
Mode <input type="radio"/> Split <input type="radio"/> Splitless <input checked="" type="radio"/> Solvent Vent	Vent Settings Pressure <input type="text" value="5.00"/> psi Flow <input type="text" value="100.00"/> ml/min Vent End <input type="text" value="0.50"/> min	Purge Flow Flow <input type="text" value="15.00"/> mL/min Purge Start <input type="text" value="5.00"/> min	<input type="button" value="OK"/>		

- b. Enter a vent Pressure and Vent End. Vent End should be set to a time earlier than any ramp's starting time.
 - c. Enter a Purge Start. Press OK.
 - d. Set the inlet temperature and ramps, as desired.
4. Press Prep Run (see page 68) before manually injecting a sample.

Large volume injection

This feature requires a G2613A or G2880A injector. It also requires an Agilent Data System:

- GC ChemStation (rev. A.10.01 or higher with the 6850 patch)
- Certy Chemical (rev. 4.07 or later).

Most vaporizing inlets are designed for liquid injections in the 1 to 5 μL range. With larger injections, the vapor cloud created when the sample vaporizes may overflow the inlet and degrade the chromatography. [Table 17](#) lists the nominal liner liquid capacities.

Table 17. Liner capacities

Liner	Nominal liquid capacity	Inertness
Open baffle	5 μL	High
Glass wool packed	25 μL	Lower, because of greater surface area

In the solvent vent mode, analytes are thermally trapped in the liner while the solvent is removed. With the solvent gone, the liner volume can be used for another injection. Injection can be repeated several times to concentrate the analytes from a large sample volume. After injection and solvent removal, the analytes are transferred to the column. This can replace the need for offline concentrating and minimize loss of sample.

The control parameters you specify are:

- The full volume of the syringe (0.1 to 100 μL ; default is 10 μL).
- If the sampler should make multiple injections into the inlet for each run according to the other parameters (single or multiple; default is single). For multiple, it issues a Start Run command at the first injection only. For single, issues a Start Run command for each run.
- The amount to inject, specified as the product of X (amount to inject in μL) and Y (the number of injections to make). (X : 0.1 to 0.5 multiplied by syringe volume; Y : 1 to 100; defaults are 0.1 x syringe volume (for X) and 1 (for Y)).
- The pause time, in seconds, between injections. This is added to the minimum hardware cycle time (0 to 100; default is 0).
- The number of times to wash the syringe with solvent and/or sample *before the first injection*. No washes are performed before the rest of the injections in a multiple injection set (0 to 15; default is 0).
- The number of times to wash the syringe with solvent *after the last injection*. No washes are performed after the rest of the injections in a multiple injection set (0 to 15; default is 0).
- The number of times to pump the syringe plunger before drawing up the measured sample. Pumps are performed only before the first injection of a multiple injection set (0 to 15; default is 0).

Calculated values

The software calculates and displays:

- Product of X (Volume per injection) and Y (Injections per run).
- The approximate total time, in minutes, to make a set of multiple injections based on the parameters entered and the mechanical cycle time of the sampler. Includes the delay between injections, pre- and post-injection dwell times, and viscosity delays.

An example

These values were used for a sample with a broad range of boiling points.

General parameters

Name	Value
Sample	C ₁₀ to C ₄₄ hydrocarbons in hexane
Mode	Solvent vent
PTV liner	Glass wool packed
Injection volume	One 10.0 µL injection (25 µL syringe)
Injection speed	Fast
Column	30 m x 320 µm x 0.25 µm HP5, p/n 19091J-413E
Column flow	4 mL/min constant flow

Inlet parameters

Name	Value	Name	Value
Init temp	40°C	Rate 2 (off)	
Init time	0.3 min	Pressure	15.6 psig
Rate 1	720°C/min	Vent pressure	0.0 psig
Final temp 1	375°C	Vent flow	100 mL/min
Final time 1	5 min	Vent End	0.2 min
Rate 2	100°C/min	Purge Start	2.0 min
Final temp 2	250°C	Purge flow	50 mL/min
Final time 2	0 min		

Oven parameters

Name	Value
Init temp	40°C
Init time	2.5 min
Rate 1	25°C/min
Final temp 1	320°C
Final time 1	10.0 min
Rate 2 (off)	

Detector parameters

Name	Value
Detector	FID
Detector temp	400°C
Hydrogen flow	40 mL/min
Air flow	450 mL/min
Makeup (N ₂)	45 mL/min

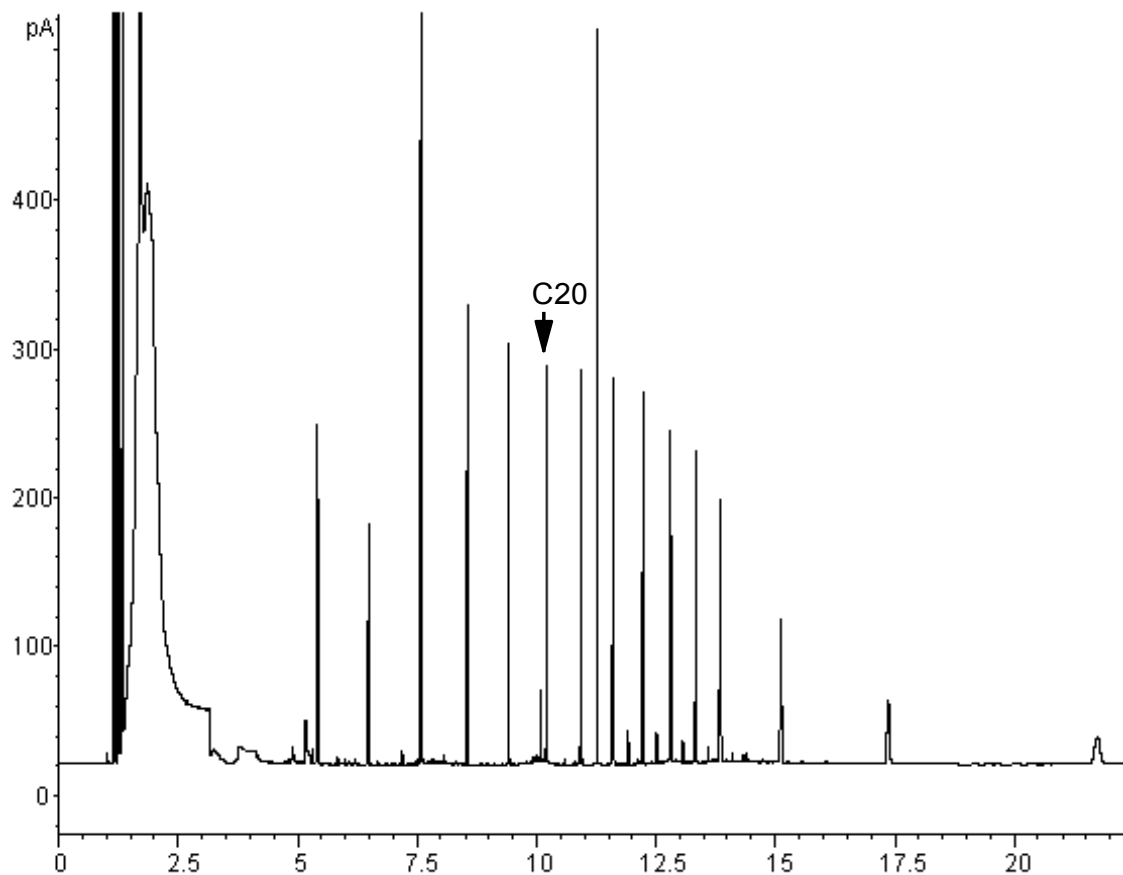

Figure 13. Chromatogram from one 10 μ L injection

The results shown in [Figure 13](#) were compared with a splitless analysis of the same sample, which should produce 100% recovery of all analytes. The data showed that, under these conditions, compounds above C_{20} were completely recovered and that the recovery was independent of injection size; Compounds lower than C_{20} were partially vented with the solvent.

Possible adjustments

Depending on what you are trying to accomplish, you have a number of possible adjustments available.

To eliminate more solvent

- Increase the Vent End, inlet initial time, and Purge Start. This will not affect analytes that are quantitatively trapped but will eliminate more of the solvent peak.
- Increase the vent flow to sweep the liner more rapidly with the same inlet timing. Increasing vent flow raises vent pressure if it is set to 0. This puts more solvent onto the column.
- Raise the inlet initial temperature to vaporize more solvent and allow more to be eliminated. This also increases the loss of volatile analytes since their vapor pressures also increase.

To improve recovery of low boiling analytes

- Reduce inlet temperature to lower the vapor pressure of the analytes and trap them more effectively. This also reduces solvent vapor pressure and more time will be needed to eliminate it.
- Use a retentive packing in the liner. Materials such as Tenax permit higher recovery of volatile analytes but may not release higher boiling compounds. This must be considered if quantitation on these high boiling peaks is desired.
- Leave more solvent in the liner. The solvent acts as a pseudo stationary phase and helps retain volatile analytes. This must be balanced against the detector's tolerance for solvent.

An example—continued

The single injection example shown on the last few pages makes it clear that a 10- μ L injection does not overload the glass wool packed liner. This means that multiple 10- μ L injections are possible.

It was decided to make 10 injections per run, each of 10- μ L size. This would increase analytical sensitivity substantially. No adjustments were made to improve recovery of the low boilers since the purpose of this analysis was to detect and measure the high boiling components.

The ChemStation estimated that 10 injections would require a total of 1.3 minutes. The following timing changes were made:

Parameter	Increased from	To
Inlet Init time	0.3 minutes	1.6 minutes
Vent End	0.2 minutes	1.5 minutes
Purge Start	2.0 minutes	3.0 minutes
Oven Init time	2.5 minutes	3.0 minutes

The result is shown in [Figure 14](#).

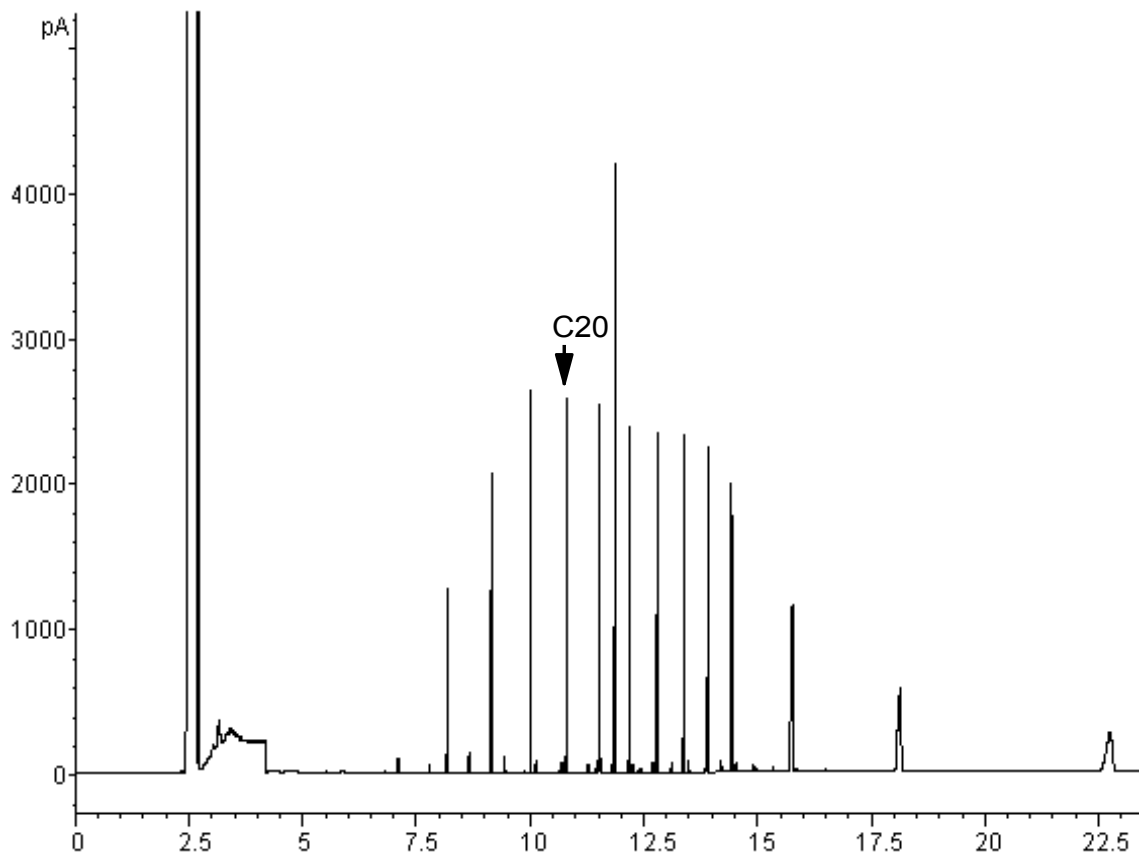

Figure 14. Chromatogram from ten 10 μ L injections

The Cool On-Column Inlet

Using a Cool On-Column Inlet

Warning This inlet introduces liquid sample directly onto a capillary column. To do this, both the inlet and the oven must be cool at injection, at or below the boiling point of the solvent. Because the sample does not vaporize immediately in the inlet, problems with sample discrimination and sample alteration are minimized. If done properly, cool-on column injection also provides accurate and precise results.

You can operate the inlet in track oven mode, where the inlet temperature follows the column oven, or you can program up to three temperature ramps. There is also a cryogenic cooling option that uses liquid CO₂ to reach sub-ambient temperatures.

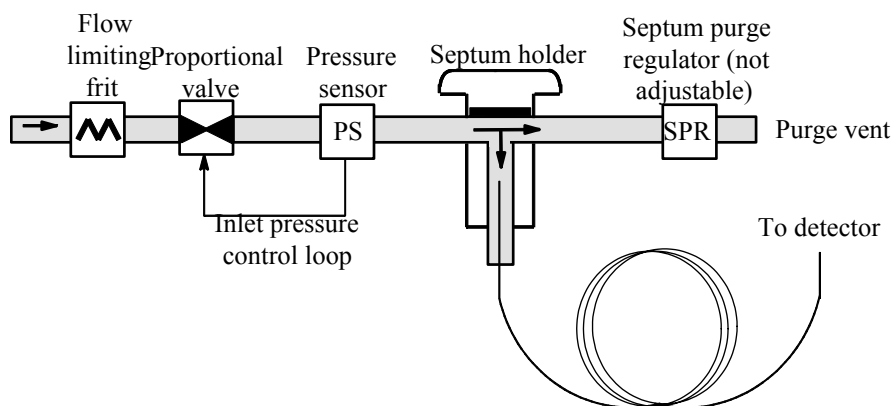

Figure 15. Cool on-column capillary inlet with EPC

Inlet temperature

CryoBlast (optional)

CryoBlast shortens the cycle time between runs. If you have a CO₂ cryogenic valve and the CryoBlast feature, you can cool the inlet to -17°C in track oven mode and -20°C in temperature program modes.

Track oven mode

In the **Track oven** mode, the inlet temperature stays 3°C higher than the oven temperature throughout the oven program. You cannot enter a temperature setpoint—it is set automatically. If you have CryoBlast, the inlet will track oven temperatures to -17°C; without CryoBlast, the lower limit is set by room temperature.

Temperature programming mode

In this mode, you can enter up to three temperature ramps so that the inlet and the oven operate independently.

At these very low oven temperatures, the inlet temperature should be at least 20°C higher than the oven temperature. This will be more than adequate for solvent focusing.

At temperatures greater than ambient, the inlet should always be at least 3°C warmer than the oven for proper control of the inlet temperature.

The oven temperature program controls the run. If it is longer than the inlet temperature program, the inlet will remain at its final temperature until the oven program (and the run) ends.

Setpoint ranges

The table below lists setpoint ranges for the inlet parameters.

Temperature	Allowed setpoint range
Track oven	3°C higher than the oven temperature to a maximum of 375°C. If you have CryoBlast, the inlet can maintain temperatures down to -17°C, although allowable oven setpoints are -60°C.
Ramped temp <i>without</i> CryoBlast	Ambient to 375°C
Ramped temp <i>with</i> CryoBlast	-20°C to 375°C

Operating the cool on-column inlet

Verify that a column and suitable insert and septum nut or cooling tower are installed. Make certain you are using a needle that will fit the column.

1. Verify that the column, carrier gas, and flow or pressure program (if used) are configured correctly. See [Flow and Pressure Control](#) on page 36.

Pressure can be set from either the column or inlet table. In constant or ramped flow mode, the pressure will be determined from the flow requirements. It is best to set flow only.

2. Press Inlet.

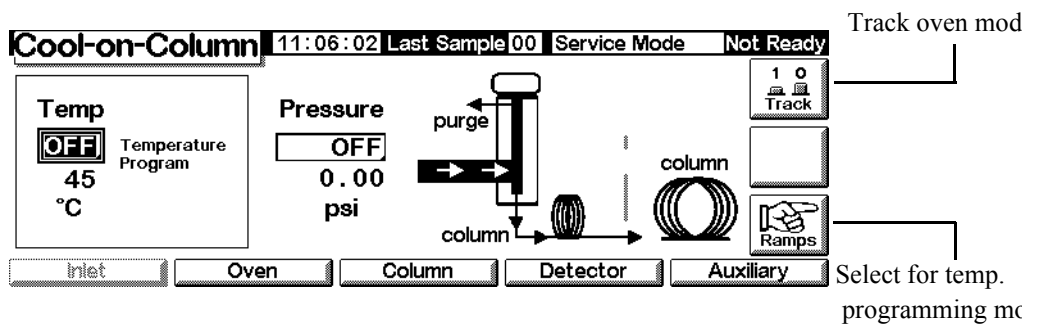

3. Choose the temperature mode
 - Press Track to use oven track mode.
 - Press Ramps to define temperature ramps. You program ramps similarly to oven ramps. See [Temperature programming](#) on page 151.
4. Enter the initial temperature (temperature programming only).
5. Enter the desired inlet pressure or flow value.
6. Inject a sample.

Thermal Conductivity Detector

Using hydrogen

Warning When using hydrogen (H₂) as a carrier gas or fuel gas, be aware that hydrogen gas can flow into the oven and create an explosion hazard. Therefore, be sure that the supply is off until all connections are made and ensure that the inlet and detector column fittings are either connected to a column or capped at all times when hydrogen gas is supplied to the instrument.

Warning Hydrogen is flammable. Leaks, when confined in an enclosed space, may create a fire or explosion hazard. In any application using hydrogen, leak test all connections, lines, and valves before operating the instrument. Always turn off the hydrogen supply at its source before working on the instrument.

Operation conditions

The detector will not work if the:

- filament is broken or shorted
- reference gas flow is set less than 5 mL/min

TCD parameters

Use the same gas for the reference gas, makeup gas, and carrier gas. Configure your inlet and detector accordingly. Refer to [Table 19](#) for maximum gas flow.

Use [Table 18](#) to select temperatures and flows for the TCD. Use [Figure 16](#) and [Figure 17](#) to find minimum source pressures.

Table 18. Recommended Flow Rates and Temperatures

Gas type	Flow range
Carrier gas (hydrogen, helium, nitrogen)	Packed column: 10–60 mL/min Capillary column: 1–5 mL/min
Reference (same gas type as carrier)	15–60 mL/min See Figure 16 to select a value
Capillary makeup (same gas type as carrier)	Packed column: 2–3 mL/min Capillary column: 5–15 mL/min

Detector temperature

If <150°C, you cannot turn the filament on.

Detector temperature should be 30°C to 50°C greater than highest oven ramp temperature.

Table 19. Maximum Gas Flows

Gas	Maximum flow, mL/min	
	Reference gas	Makeup gas
Nitrogen	100	12
Helium	100	12
Hydrogen	100	12
Argon	100	12

Use [Figure 16](#) to select a value for reference gas flow rate for capillary and packed columns. Any ratio within ± 0.25 of that in the graph is suitable. For example, for a combined column and makeup gas flow of 30 mL/min, your reference gas flow rate should be 1.5 to 2.0 times greater, or 45 to 60 mL/min.

When using packed columns, we recommend a small makeup gas flow (2 to 3 mL/min) to get the best peak shapes.

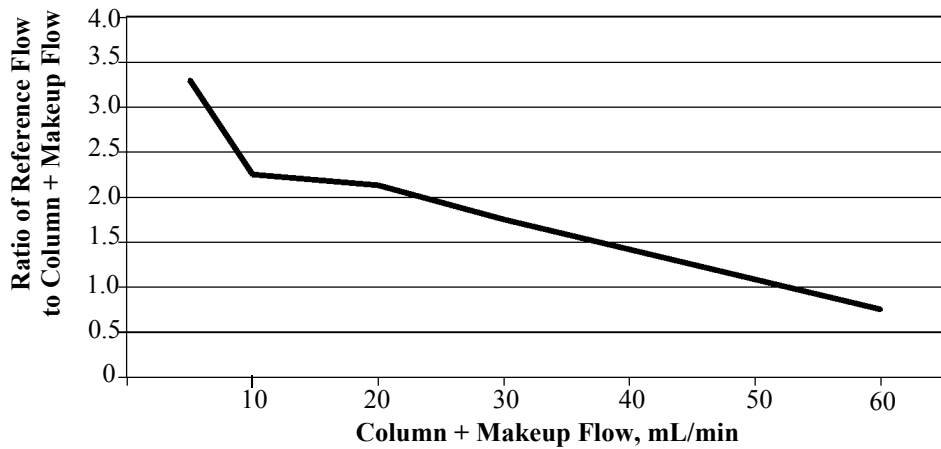
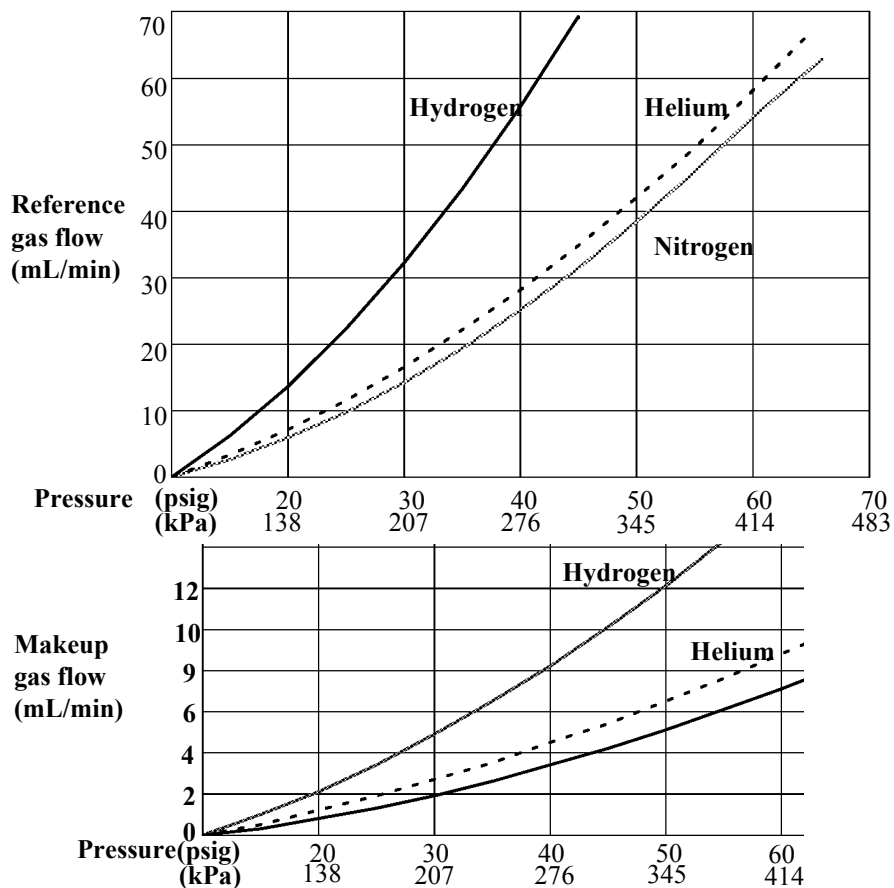

Figure 16. Selecting the reference gas flow



* Pressures include an allowance for the pressure drop in the pneumatics

Figure 17. Typical source pressure/flow relationships, makeup and reference gases at 25°C and 1 atmosphere pressure

Makeup gas

Makeup gas enters the detector near the end of the column. It speeds the sample through so that the separation achieved by the column is not lost by remixing in the detector. Makeup gas is not required with packed columns.

If the capillary column is *not configured*, the makeup flow is constant. See [Configuring the column](#) on page 38 for how to configure a column.

If the capillary column is *configured*, you have a choice of two makeup gas modes.

To select the makeup gas mode

The Constant Makeup mode gives a constant flow of makeup gas to the detector.

The Constant Combo mode gives a variable flow of makeup gas to the detector. As column flow changes, the makeup flow adjusts to provide a constant combined flow to the detector.

Display this screen.

Status / Settings / Detector / More / Makeup Mode / Enter

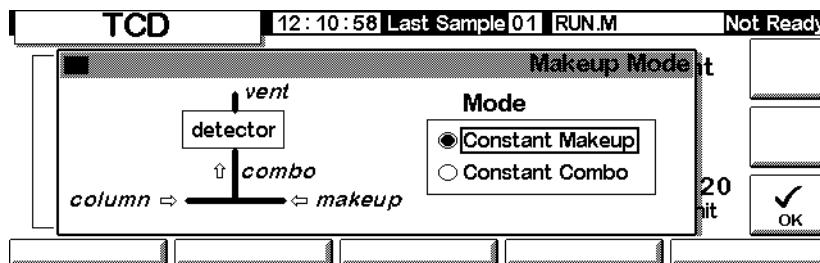

Select a makeup mode and press OK.

Status / Settings / Detector

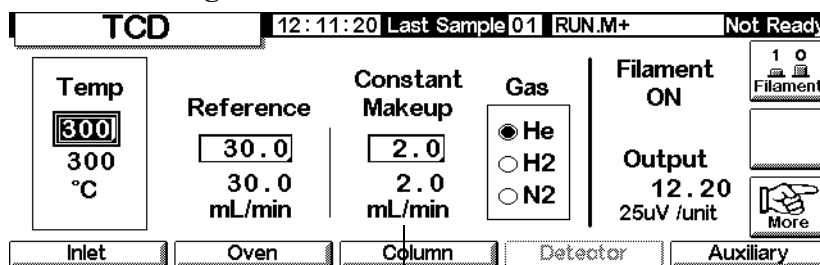

Makeup gas flow

To set the makeup gas flow

The detector screen now reflects your makeup gas mode choice. Enter either the Constant Makeup flow or the Constant Combo flow.

Polarity

Attempts to analyze for helium and hydrogen using nitrogen or argon carrier gas give negative peaks. While some GC systems can integrate negative peaks, a better solution is to invert that region of the signal and process the resulting positive peaks.

Signal inversion is usually done using Run Table entries (see [Run Table](#) on page 58), but can be done manually as shown here.

To invert the detector signal

1. Display this screen.

Status / Settings / Detector / More / Polarity

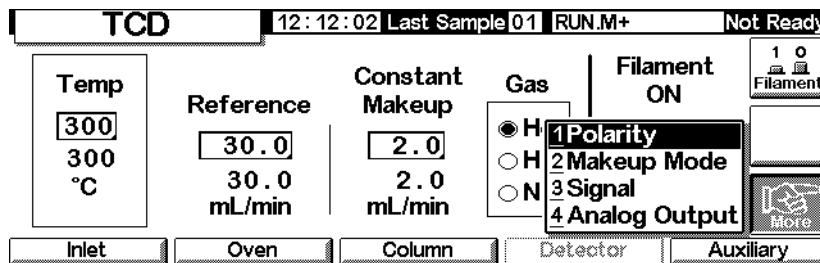

2. Press Enter to display the next screen.

Status / Settings / Detector / More / Polarity / Enter

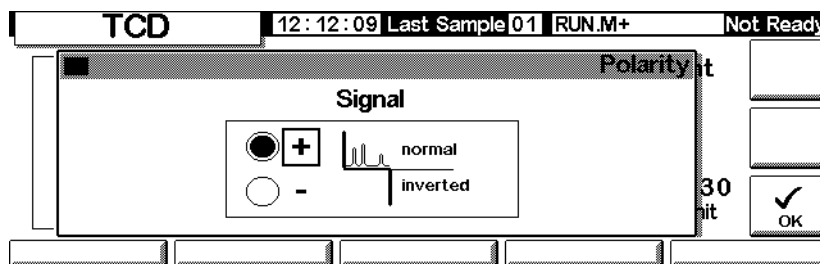

3. Select normal or inverted Signal.

Analyzing for hydrogen

Hydrogen is the only element with thermal conductivity greater than helium, and small amounts of hydrogen (<20%) in helium at moderate temperatures have thermal conductivities less than either component alone. If you are using helium carrier gas, a hydrogen peak may appear as positive, negative, or as a split peak.

There are two solutions to this problem:

- Use nitrogen or argon as carrier gas. This eliminates problems inherent with using helium as carrier, but reduces sensitivity to components other than hydrogen.
- Operate the detector at higher temperatures—from 200°C to 300°C

To find a suitable detector operating temperature, analyze a known range of hydrogen concentrations, raising the detector temperature until the hydrogen peak shows normal shape and is always in the same direction (negative relative to response to air or propane) for all concentrations.

Since hydrogen peaks are negative, you must use signal inversion at appropriate times during the analysis.

Signal selection

Several types of signals can be selected as the signal output. The selected signal type is available as the SIG connector on the rear panel for processing by an integrator, strip chart recorder, or other external device. The selected signal is also digitally output through the RS-232 connector and optional LAN communications card.

To select the output signal

1. Display this screen.

Status / Settings / Detector / More / Signal

The screenshot shows the TCD control interface with the following elements:

- Header:** TCD | 12:12:43 | Last Sample 01 | RUN.M+ | Not Ready
- Temp:** 300 (input field), 300 °C (display)
- Reference:** 30.0 (input field), 30.0 mL/min (display)
- Constant Makeup:** 2.0 (input field), 2.0 mL/min (display)
- Gas:** Radio buttons for H₂ (selected), H, N
- Filament:** ON
- Signal Selection Menu:**
 - 1 Polarity
 - 2 Makeup Mode
 - 3 Signal (highlighted)
 - 4 Analog Output
- Buttons:** Inlet, Oven, Column, Detector, Auxiliary
- Other UI Elements:** Filament status (1 0), More button.

2. Press **Enter** to display the next screen.

Status / Settings / Detector / More / Signal / Enter

The screenshot shows a control panel for a TCD. At the top, it displays 'TCD', the time '13:34:16', 'Last Sample 00', 'Default+', and 'Not Ready'. The main menu is titled 'Signal' and contains the following options:

- Detector**
- Column Comp
- Detector-Column Comp
- Test Chromatogram
- Other

Below the menu, there are three input fields:

- Zero**: 0.0
- Signal**: 0.00
- PW**: 0.01 min 20 Hz

On the right side, there are two buttons: 'ZERO' and 'OK'.

3. Select one of the four signals in the list.
 - *Detector*—the raw signal produced by the detector.
 - *Column Comp*—the stored column compensation profile for this detector.
 - *Detector - Column Comp*—the result of subtracting the column compensation profile from the detector signal.
 - *Test Chromatogram*—stored in the instrument. It provides a reproducible signal to test external signal processing equipment.

The signal type can be changed to other types by the ChemStation or Cerity Chemical.

To zero the signal

- Enter a value in the **Zero** field. The value is subtracted from all future signal values.
- OR
- Leave the **Zero** field blank, then press the **Zero** key. The GC saves the present value of the signal and subtracts it from all future signal values.

The peak width (PW) window

This window displays the optimal peak width for the displayed digital signal data rate.

Analog output

To scale a signal to fit on a strip chart recorder:

1. Display this screen.

Status / Settings / Detector / More / Analog Output

TCD					12:13:17	Last Sample 01	RUN.M+	Not Ready
Temp	Reference	Constant Makeup	Gas	Filament				
300 300 °C	30.0 30.0 mL/min	2.0 2.0 mL/min	<input checked="" type="radio"/> H <input type="radio"/> H <input type="radio"/> N	ON	1 <input type="checkbox"/> Filament			
			<input type="radio"/> 1 Polarity <input type="radio"/> 2 Makeup Mode <input type="radio"/> 3 Signal <input checked="" type="radio"/> 4 Analog Output		More			
Inlet	Oven	Column	Detector	Auxiliary				

2. Press Enter to display the next screen.

Status / Settings / Detector / More / Analog Output / Enter

Analog Output			
Output	Attn	Range	
0-1mV	0		<input type="checkbox"/> Fast Peaks
0-1V, 0-10V	0	0	Not For TCD

3. Enter appropriate values for your output signal. Both Range and Attenuation are binary (powers of 2) scalars. A change of 1 unit in either direction alters the signal by a factor of 2.
 - *Range* scales the signal available through the three analog outputs.
 - *Attenuation* scales only the 0–1 mV output.

Fast Peaks is not available for use with TCD.

Using the TCD

Display this screen.

Status / Settings / Detector

TCD		12:14:16	Last Sample 01	RUN.M+	Not Ready
Temp <input type="checkbox"/> OFF 300 °C	Reference <input type="checkbox"/> OFF 0.4 mL/min	Constant Makeup <input type="text" value="2.0"/> 2.0 mL/min	Gas <input checked="" type="radio"/> He <input type="radio"/> H2 <input type="radio"/> N2	Filament OFF Signal 0.00 25uV /unit	<input type="checkbox"/> Filament <input type="button" value="More"/>
Inlet	Oven	Column	Detector	Auxiliary	

1. Set the detector temp (see [Recommended Flow Rates and Temperatures](#) on page 126). Avoid temperatures above the column limit because part of the column extends into the detector block.
2. Enter a value for the Reference gas flow (see [Figure 16](#) for selecting the reference gas flow).
3. Verify that the makeup gas type is the same as that plumbed to your instrument
 - If your capillary column is *not configured*, enter a constant makeup gas flow rate
 - If your capillary column is *configured*, select a makeup mode and flow rate (see [Makeup gas](#) on page 128)
 - If you are using a packed column, either turn off the makeup gas or set a small flow rate of 2–3 mL/min.
4. Turn the filament on. Allow about 30 minutes for thermal stabilization.
5. If necessary, use signal inversion (see [Polarity](#) on page 129) to invert negative-going peaks. When a sample contains components giving both positive- and negative-going peaks, use Run Table events to switch signal inversion on and off during the run.

Flame Ionization Detector

Using hydrogen

Warning When using hydrogen (H₂) as a carrier gas or fuel gas, be aware that hydrogen gas can flow into the oven and create an explosion hazard. Therefore, be sure that the supply is off until all connections are made and ensure that the inlet and detector column fittings are either connected to a column or capped at all times when hydrogen gas is supplied to the instrument.

Warning Hydrogen is flammable. Leaks, when confined in an enclosed space, may create a fire or explosion hazard. In any application using hydrogen, leak test all connections, lines, and valves before operating the instrument. Always turn off the hydrogen supply at its source before working on the instrument.

Detector Operation Notes

The detector will not work if:

- Air or hydrogen flow is set at Off or set at 0.0
- The flame won't light.

Detector Shutdown

If the GC shuts a detector gas down due to a pneumatics or ignition failure, it also turns off all detector functions except the heater and the makeup gas flow.

Jets

Your detector is shipped with a capillary column jet. If you are doing simulated distillation or high-temperature runs, or are using a packed column, you must change the jet. Refer to [Table 20](#).

Table 20. Jets for the FID

Jet type	Part no.	Jet tip id
Capillary	19244-80560	0.29 mm (0.011-inch)
Packed	18710-20119	0.47 mm (0.018 in.)
Packed wide-bore <i>(use with high-bleed applications)</i>	18789-80070	0.030 in.
High-temperature <i>(use with simulated distillation)</i>	19244-80620	0.47 mm (0.018-inch)

Electrometer

The electrometer amplifies the current produced when the sample burns. You do not need to turn the electrometer on and off when operating your FID. The only time you need to turn off the electrometer is when cleaning the detector. Otherwise, leave it on.

Caution Do not turn off the electrometer during a run. It will cancel detector output.

To turn the electrometer on or off

1. Display this screen.

Status / Settings / Detector / More / Electrometer / Enter

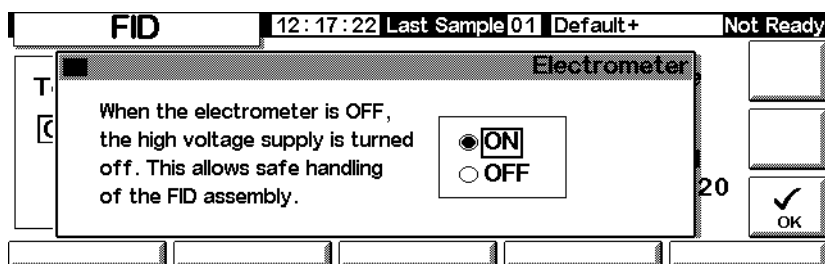

2. Turn the electrometer ON or OFF using the arrow keys. Press OK.

Makeup gas

Makeup gas enters the detector near the end of the column. It speeds the sample through so that the separation achieved by the column is not lost by remixing in the detector.

Makeup gas mode

If the column is *not configured*, the makeup flow is constant (see [Configuring the column](#) on page 38 for how to configure a column).

If the column is *configured*, you have a choice of two makeup gas modes.

- The `Const Makeup` mode gives a constant flow of makeup gas to the detector.
- The `Constant Combo` mode provides a variable flow of makeup gas to the detector. As column flow changes, the makeup flow adjusts to provide a constant combined flow to the detector.

To select a makeup gas mode

1. Display this screen.

Status / Settings / Detector / More / Makeup Mode / Enter

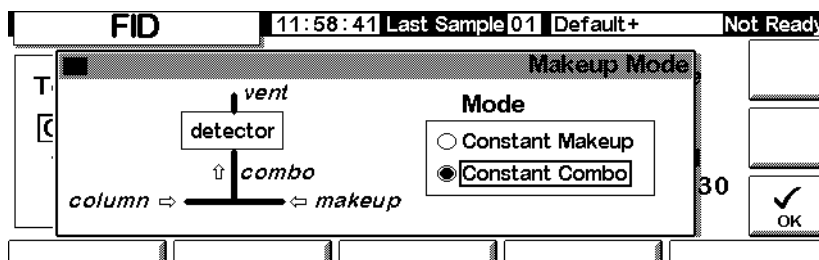

2. Select either Constant Makeup or Constant Combo. Press OK to return to the FID screen.

Status / Settings / Detector

FID		13:34:47	Last Sample 00	Default+	Not Ready
Temp <input type="checkbox"/> OFF 26 °C	Flame OFF	Gases H2 OFF 0.0 mL/min	Air OFF 0.0 mL/min	Constant Makeup OFF 0.0 mL/min	Gas <input type="radio"/> He <input type="radio"/> H2 <input checked="" type="radio"/> N2
Flame OFF		Output 0.00 pA		<input type="checkbox"/> Flame	<input type="button" value="More"/>
<input type="button" value="Inlet"/>	<input type="button" value="Oven"/>	<input type="button" value="Column"/>	<input type="button" value="Detector"/>	<input type="button" value="Auxiliary"/>	

Flow Value

3. Enter the flow value and press enter.
4. Press Esc to return to the previous screen.

To set the makeup gas flow

The detector screen now reflects your makeup gas mode choice. Enter either the Constant Makeup flow or the Constant Combo flow.

Signal selection

Several types of signals can be selected as the signal output. The selected signal type is available as the SIG connector on the rear panel for processing by an integrator, strip chart recorder, or other external device. The selected signal is also digitally output through the RS-232 connector and optional LAN communications card.

To select the output signal

1. Display this screen.

Status / Settings / Detector / More / Signal / Enter

Signal	
<input type="radio"/> Detector	Zero <input type="checkbox"/> OFF
<input type="radio"/> Column Comp	Signal <input type="text" value="0.00"/>
<input type="radio"/> Detector-Column Comp	PW <input type="text" value="0.01 min"/> <input type="text" value="20 Hz"/>
<input checked="" type="radio"/> Test Chromatogram	
<input type="radio"/> Other 10	

2. Select one of the four signals in the list.
 - *Detector*—the signal produced by the detector.
 - *Column Comp*—the stored column compensation profile (see [Column compensation](#) on page 154).
 - *Detector - Column Comp*—the result of subtracting the column compensation profile from the detector signal.
 - *Test Chromatogram*—stored in the instrument. It provides a reproducible signal to test external signal processing equipment.

Signal type can be changed to other types by the ChemStation or Cerity Chemical.

3. Press OK.

To zero the signal

- Enter a value in the `Zero` field. The value is subtracted from all future signal values. Then, press OK.

OR

- Leave the `Zero` field blank, then press the `Zero` key. The GC saves the present value of the signal and subtracts it from all future signal values. Then, press OK.

The Peak Width window

This window displays the digital signal data rate.

Analog output

These controls scale a signal to fit on a strip chart recorder.

To adjust the output signal

1. Display this screen.

Status / Settings / Detector / More / Analog Output / Enter

Analog Output		
Output	Attn	Range
0-1mV	0	0
0-1V, 0-10V	0	0
		<input type="checkbox"/> Fast Peaks
		Not For TCD

2. Enter appropriate values for your output signal. Both Range and Attenuation are binary (powers of 2) scalars. A change of 1 unit in either direction alters the signal by a factor of 2.
 - *Range* scales all three analog outputs
 - *Attenuation* scales only the 0–1 mV output
3. Select the Fast Peaks feature, if desired. Fast Peaks allows detection of peaks as narrow as 0.004 minutes, while the minimum width for the standard speed is 0.01 minutes. To use the Fast Peaks feature, your integrator must be fast enough (at least a 15 Hz bandwidth) to process the data coming from the GC.
4. Press OK.

Automatic reignition—Lit Offset

Lit Offset is the expected difference between the FID output with the flame lit and the output with the flame off. If the output falls below this value, the FID assumes that the flame is out and tries to reignite several times. If the output does not increase by at least the **Lit Offset**, the detector shuts down all functions except temperature and makeup gas flow.

The default setting for `Lit Offset` is 2.0 picoamps. This value is good for all but very clean gases and systems. You may want to change this setpoint if:

- your detector is attempting to reignite when the flame is still on, thus producing a shutdown
- your detector is not trying to reignite when the flame is out

To adjust the Lit Offset

1. Display this screen.

Status / Settings / Detector / More / Lit Offset / Enter

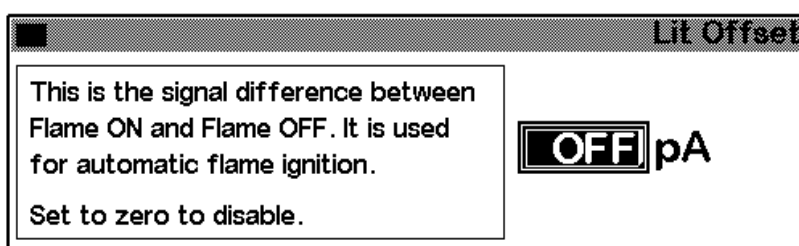

2. Adjust the value as indicated by the discussion above. If you enter zero, the box's contents change to `Off`. Press OK.

FID parameters

Use the information in [Table 21](#) when selecting flows. Select a minimum source pressure from [Figure 18](#).

Table 21. Recommended Flows

Gas type	Flow range mL/min	Suggested flow mL/min
Carrier gas (hydrogen, helium, nitrogen)	Capillary columns: 1 to 5 Packed columns: 10 to 60	
Detector gases		
Hydrogen	24 to 60*	40
Air	200 to 600*	450
Column plus capillary makeup Recommended: nitrogen Alternate: helium	10 to 60	50

* The hydrogen-to-air ratio should be between 8% and 12% to keep the flame lit.

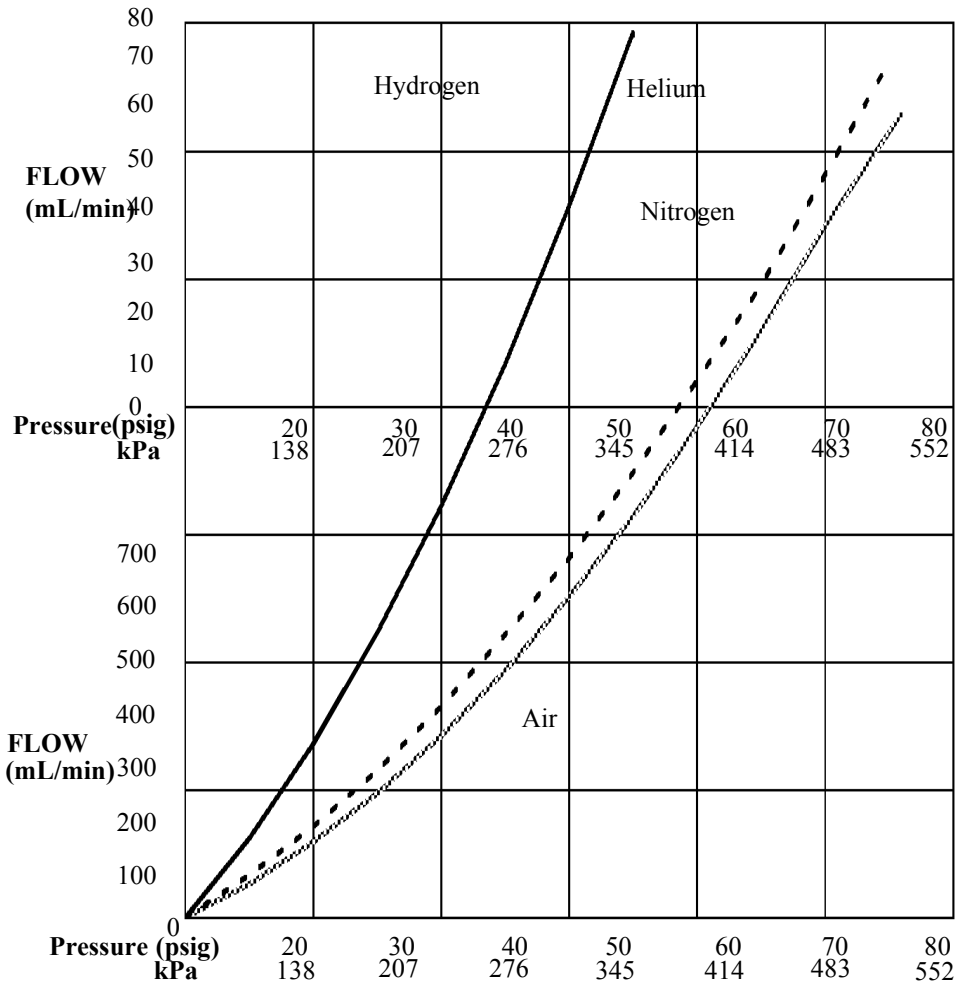

* Pressures include an allowance for the pressure drop in the pneumatics manifold.

Figure 18. Typical source pressure/flow relationships for FID gases at 25°C and 1 atmosphere pressure

Using the FID

Warning Verify that a column is installed or the FID column fitting is plugged before turning on the air or hydrogen. An explosion may occur if air and hydrogen are allowed to leak into the oven.

1. Display this screen.

Status / Settings / Detector

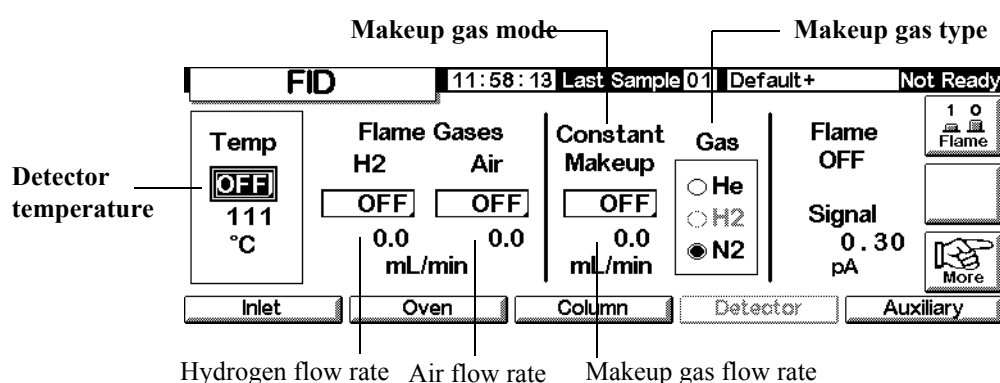

2. Set the detector temperature. The temperature must be greater than 150°C for the flame to light and should be approximately 20°C higher than the highest oven temperature.
3. Enter values for the hydrogen and air flow rates.
4. Verify that the makeup gas type is the same as that plumbed to your instrument.
 - If your capillary column is *not configured*, enter a makeup gas flow. Only constant flow is available in this case. See [Configuring the column](#) on page 38 for how to configure a column.
 - If your capillary column is *configured*, press More, select Makeup Mode, and press Enter to display the next screen.
 - If you are using a *packed* column, turn the makeup gas flow off.

Status / Settings / Detector / More / Makeup Mode / Enter

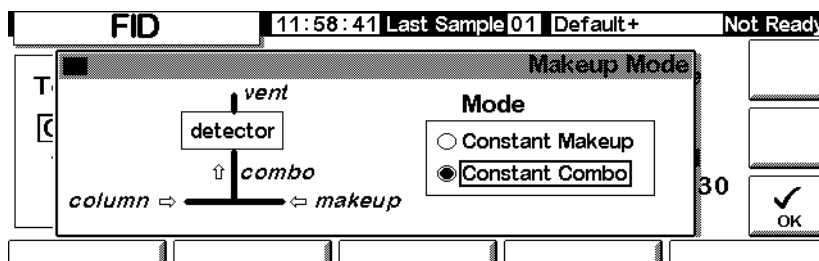

5. Select a makeup mode. Press OK to return to the previous screen. Enter the makeup or combo flow rate.
6. Press the **F1** key to turn on the air and hydrogen and initiate the ignition process. The signal typically increases to 5 to 20 pA after ignition. Verify that the flame is lit by holding a cold, shiny surface, such as a mirror or chrome-plated wrench, over the collector exit. Steady condensation indicates that the flame is lit.

The Microcell Electron Capture Detector

General Information

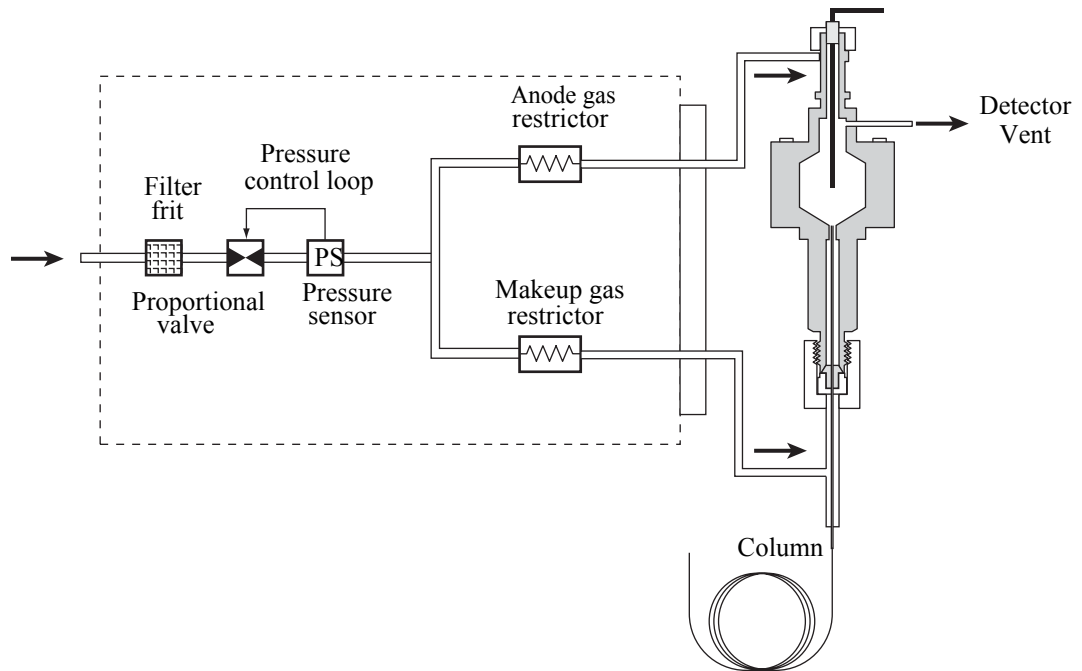

Figure 19. μECD pneumatics

Linearity

The μECD response factor versus concentration curve is linear for four orders of magnitude or more (linear dynamic range = 10^4 or higher) for a broad range of compounds. You should still run a calibration curve on your samples to find the limits of the linear range for your materials.

Detector gas

The μ ECD operates with either nitrogen or argon/methane as the makeup and anode gas.

Because of the high detector sensitivity, carrier and makeup gas must be dry and oxygen-free. Moisture, chemical, and oxygen traps in good condition should be installed in carrier and makeup gas supply lines.

Temperature

To prevent peak tailing and to keep the cell clean, the detector temperature should be set higher than the highest oven temperature used—the setpoint should be based on the elution temperature of the last compound. If you operate at excessively high temperatures, your results will not necessarily improve and you may increase sample and column decomposition.

Electrometer

The detector configuration contains an on/off setpoint for the electrometer. Keep the electrometer on all the time when operating your detector.

Analog Output

If you intend to use the analog output from the μ ECD, you must set the output Range to 10, as follows:

1. Display this screen.

Status / Settings / Detector / More / Analog Output / Enter

Microcell ECD			16:53:40	Last Sample 00	DEF_GC.M	Ready
Analog Output						
Output	Attn	Range	<input type="checkbox"/> Fast Peaks Not For TCD			
0-1mV	0	10	00			
0-1V, 0-10V	0		<input checked="" type="checkbox"/> OK			

2. Enter appropriate values for your output signal. Both Range and Attenuation are binary (powers of 2) scalars. A change of 1 unit in either direction alters the signal by a factor of 2.
 - *Range* (value: 10) scales all three analog outputs
 - *Attenuation* scales only the 0–1 mV output
3. Select the Fast Peaks feature, if desired. Fast Peaks allows detection of peaks as narrow as 0.004 minutes, while the minimum width for the standard speed is 0.01 minutes. To use the Fast Peaks feature, your integrator must be fast enough (at least a 15 Hz bandwidth) to process the data coming from the GC.
4. Press OK.

Operating the Detector

Use the information in [Table 1](#) when selecting temperatures and flows. Maximum source pressure must not exceed 100 psi. Use the maximum source pressure to achieve maximum makeup flow rate.

Table 1. Operating Parameters

Gas	Recommended flow range
Carrier gas	
Packed columns (nitrogen or argon-methane)	30 to 60 mL/min
Capillary columns (hydrogen, nitrogen, or argon-methane)	0.1 to 20 mL/min, depending on diameter
Capillary makeup (nitrogen or argon-methane)	10 to 150 mL/min (30 to 60 mL/min typical)
Temperature	
250°C to 400°C	
Typically set Detector Temperature 25°C greater than the highest oven ramp temperature.	

Notes

- If the carrier gas type is different from the makeup gas type, the makeup gas flow rate must be at least three times the carrier gas flow rate.
- μ ECD sensitivity can be increased by reducing the makeup gas flow rate.
- μ ECD chromatographic speed (for fast peaks) can be increased by increasing the

makeup gas flow rate.

Verify that your detector gases are connected, a column is properly installed, and the system is free of leaks. Set the oven temperature and the inlet temperature and flow. Make sure your carrier gas type is the same as that plumbed to your GC.

1. Display this screen.

Status / Settings / Detector

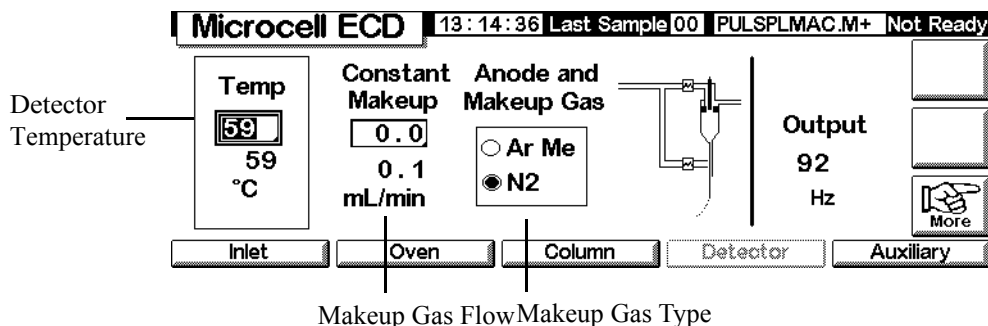

2. Set the detector temperature. To keep the μ ECD cell clean, this temperature must be higher than the oven temperature.

Caution

Detector electronics depend on the correct gas configuration.

3. Verify that the makeup gas type is the same as that plumbed to your instrument. Change the gas type, if necessary.
4. Enter a value for the makeup gas.

If you are using packed columns, turn off the makeup gas.

If your capillary column is *configured*, select a new flow mode, if desired, and set the makeup or combined gas flow.

If your capillary column is *not configured*, only constant makeup flow is available. Enter a makeup gas flow.

Column Oven

Oven capabilities

- Temperature range 5°C above ambient to 350°C
With CO₂ cryo: -20°C to 350°C
- Temperature programming - up to six ramps with seven plateaus
- Maximum run time - 999.99 minutes
- Temperature ramp rates - 0 to 120°C/min
- The oven accommodates one inlet, one detector, and one column.

Oven safety

Manual shutdown

Raising the oven lid turns off power to the oven heater, fan, and cryogenic valve (if installed) but maintains the setpoints in memory. Closing the oven lid returns the oven to normal operation.

Automatic shutdown

If the oven cannot attain or maintain an entered setpoint temperature during normal operation, the GC turns the oven fan and heater off, flashes the shutdown announcement on the Status screen, and displays a message.

Possible problems include:

- The oven vent flaps are not working
- The oven fan, heater, or temperature sensor is not working properly
- There is an electronic problem

When an automatic shutdown occurs, the oven remains off until it is reset using the Control Module (**Status / Settings / Oven**). You may need to turn the instrument power off, then on again.

The oven also automatically shuts down when the lid is opened.

Oven setup

To configure the oven:

1. Display this screen.

Status / Setup / Oven Setup

Oven Setup		13:08:42	Last Sample 01	DEF_GC.M+	Not Ready
Equib Time	Cryo Type CO2				
<input type="text" value="0.00"/> min	<input type="checkbox"/> Oven Cryo	<input type="checkbox"/> Quick Cryo Cool			
Max Temp	Cryo Timeout	Ambient Temp			
<input type="text" value="350"/> °C	<input type="text" value="120"/> min	<input checked="" type="checkbox"/> Cryo Fault	<input type="text" value="25"/> °C		
<input type="text"/>	<input type="text"/>	<input type="text"/>	<input type="text"/>	<input type="text"/>	<input type="text"/>

2. Enter values for Equib Time and Max Temp.
 - *Equib Time*—When the oven temperature reaches $\pm 1^\circ\text{C}$ of setpoint. The GC waits for the time specified before declaring the oven ready.
 - *Max Temp*—The oven temperature limit. Most columns and many accessories have specific temperature limits. When configuring Max Temp, these limits should be considered to prevent damage.
3. If a cryogenic valve is installed and you wish to use it, select Enable Oven Cryo. Enter values for Cryo ambient temp and Cryo Timeout.

Caution

If you are using cryogenic oven cooling, the flanged column hanger must be used to avoid column cold spots.

When cryogenic cooling is not needed or cryogenic coolant is not available, do not select this item. If this is not done, proper oven temperature control may not be possible, particularly at temperatures near ambient.

- *Cryo ambient temp*—The temperature in the laboratory. This setpoint determines the temperature at which cryogenic cooling begins. For regular cryo operation, the temperature is Cryo ambient temp + 25°C. For Quick Cryo Cool, the temperature is Cryo ambient temp + 45°C.

- *Cryo Timeout*—Timeout occurs, and the oven shuts off, when a run does not start within a specified time (10 to 120 minutes) after the oven equilibrates. Turning *Cryo Timeout* off disables this feature. We recommend that it be turned on to conserve coolant at the end of a method or if automation fails.
4. If available, enable or disable *Cryo Fault* and *Quick Cryo Cool*.
- *Cryo Fault*—Shuts the oven down if it does not *reach* (stabilization will take longer) setpoint temperature after 16 minutes of continuous cryo operation
 - *Quick Cryo Cool*—This feature is separate from *Enable Oven Cryo*. *Quick Cryo Cool* makes the oven cool faster after a run. This feature is useful when maximum sample throughput is necessary; however, it uses more coolant. *Quick Cryo Cool* turns off soon after the oven reaches its setpoint and *Enable Oven Cryo* takes over, if needed.

Creating an isothermal run

An isothermal run is one in which the oven is maintained at a constant temperature. To create an isothermal run, set the programming rate ($^{\circ}\text{C}/\text{min}$) to zero.

To set up an isothermal oven program

Display this screen.

Status / Settings

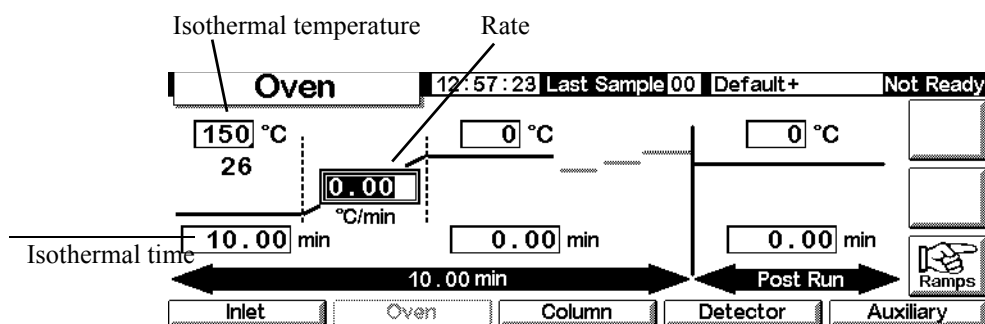

1. Enter the oven temperature for the run in the isothermal temperature field ($^{\circ}\text{C}$). Press **Enter**.
2. In the Isothermal time (min) field, enter the number of minutes that you want the oven to stay at this temperature. This time is the duration of the run (maximum 999.99 minutes). Press **Enter**.

3. Set the Rate ($^{\circ}\text{C}/\text{min}$) to 0.00. Press Enter. This completes the isothermal run setup.
4. Enter a Post-Run temperature and time if you want to flush remaining high-boiling components out of the column.

Temperature programming

You can program the oven temperature from an initial temperature to a final temperature using up to six ramps during a run.

Total length of a run is determined by its oven temperature program. The maximum allowable time for a run is 999.99 minutes. If the program is still running at that time, the run terminates.

The highest temperature programming rate that you can achieve depends on many factors, including the room temperature, temperatures of the inlet and detector, the amount of material inside the oven (columns, valves, etc.), and whether or not this is the first run of the day. Typical values are in [Table 22](#).

Table 22. Oven Ramp Rates*

Temperature range ($^{\circ}\text{C}$)	Maximum-ramp rates ($^{\circ}\text{C}/\text{min}$)
50 to 75	120
75 to 115	95
115 to 175	65
175 to 300	45
300 to 350	35

* These rates are for the standard GC. For the fast GC, maximum ramp rates are approximately three times faster.

If cryogenic oven cooling is installed, the higher ramp rates may not be possible.

Single-ramp temperature program

A single-ramp temperature program (see Figure 20) changes the oven temperature from an initial value to a final value at a specified rate and holds at the final temperature for a specified period of time.

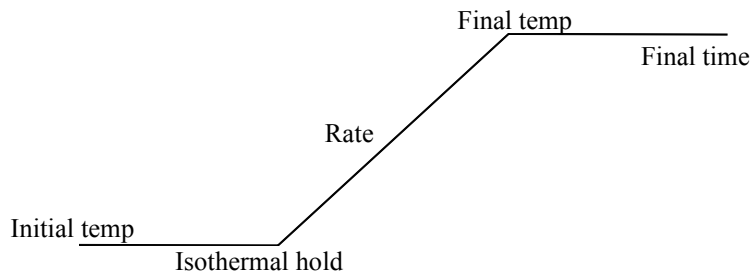

Figure 20. Single ramp

To create a single-ramp program

The example on the following screen begins at 50°C, holds that temperature for 2 minutes, then increases temperature to 150°C at a rate of 10°C/min and stays there for 5 min.

1. Display this screen.

Status / Settings / Oven

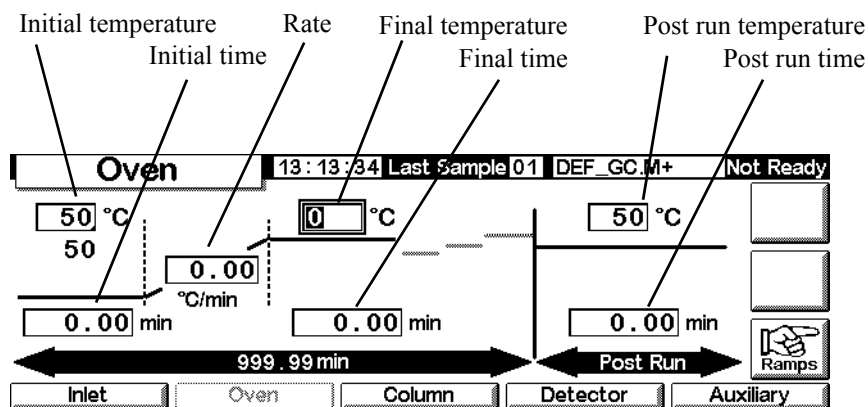

2. Enter the starting conditions—Initial temperature (50°C) and Initial time (2 min).
3. Enter the rate (10°C/min) at which the oven temperature is to increase.
4. Enter the Final temperature and Final time (150°C for 5 min).

- If you wish to clean out the column before cooling to the starting temperature, enter Post Run temperature and Post Run time.
- If you are certain that the most recent program used a single ramp, you can skip the remaining steps. If you are not sure, continue by pressing Ramps.

Status / Settings / Oven / Ramps

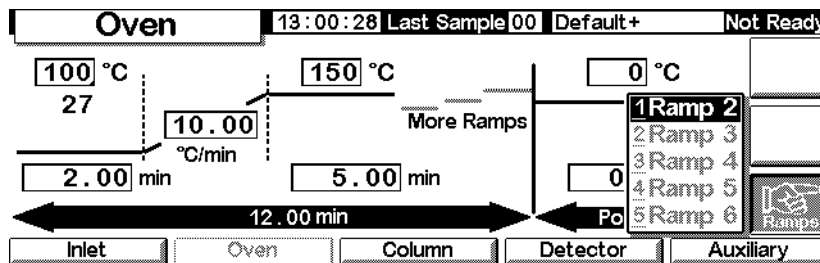

- Select Ramp 2 and press Enter.

Status / Settings / Oven / Ramps / Ramp 2

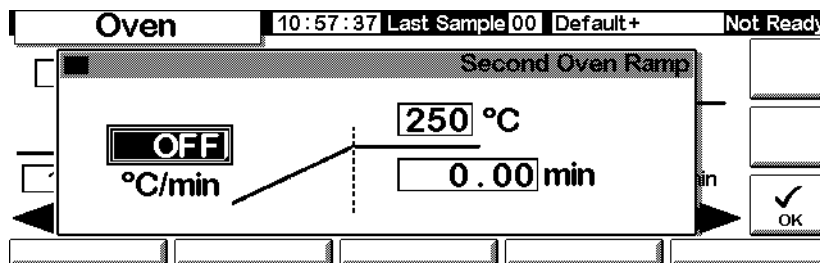

- To ensure that the program is single-ramp, set the °C/min value to OFF (0 °C), then press OK. The program ends when it encounters a rate of OFF.

Creating multiple-ramp temperature programs

A multiple-ramp temperature program (see [Figure 21](#)) changes the oven temperature from an initial value to a final temperature, but with various rates, times, and temperatures in between. Multiple ramps can be programmed for temperature *decreases* as well as increases.

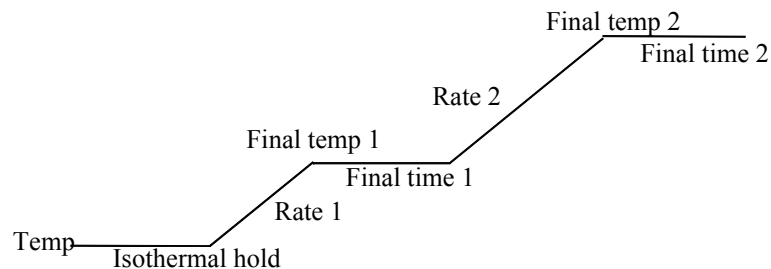

Figure 21. Multiple ramp

To create a multiple-ramp program

The example from the previous section begins at 50°C, holds that temperature for 2 min, then increases temperature to 150°C at a rate of 10°C/min and stays at 150°C for 5 min. It then continues with a second ramp in this section by rising at 4°C/min to 200°C and holds for 2 min.

1. Set up the first oven ramp as described on the preceding page.
2. When setting up Ramp 2, enter 4 in the °C/min field, 200 in the °C field, and 2 in the min field.

Status / Settings / Oven / Ramps / Ramp 2

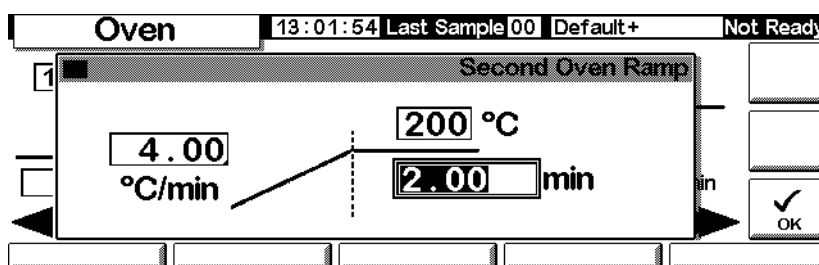

3. Press OK to return to the previous screen
4. If you are certain that the most recent program used only two ramps, you can skip the remaining steps. If you're not sure, continue by pressing Ramps. Select Ramp 3 and press Enter.
5. Set the °C/min value to OFF, then press OK. The program ends when it encounters a rate of OFF.
6. Add more ramps, up to a maximum of six, in the same way.

Column compensation

Although temperature programming improves peak shapes, it also causes a rising baseline that may make integration difficult. This is usually not a problem with a thermal conductivity detector because of its low sensitivity, but it can be a severe problem with a flame ionization detector.

Column compensation corrects for baseline rise by storing a profile of a blank run—one made with no sample injection. This profile is subtracted from subsequent sample runs to eliminate the rising baseline. [Figure 22](#) illustrates the concept.

All conditions *must* be identical in the compensation run and the real run: same detector and column, same temperature and gas flow conditions.

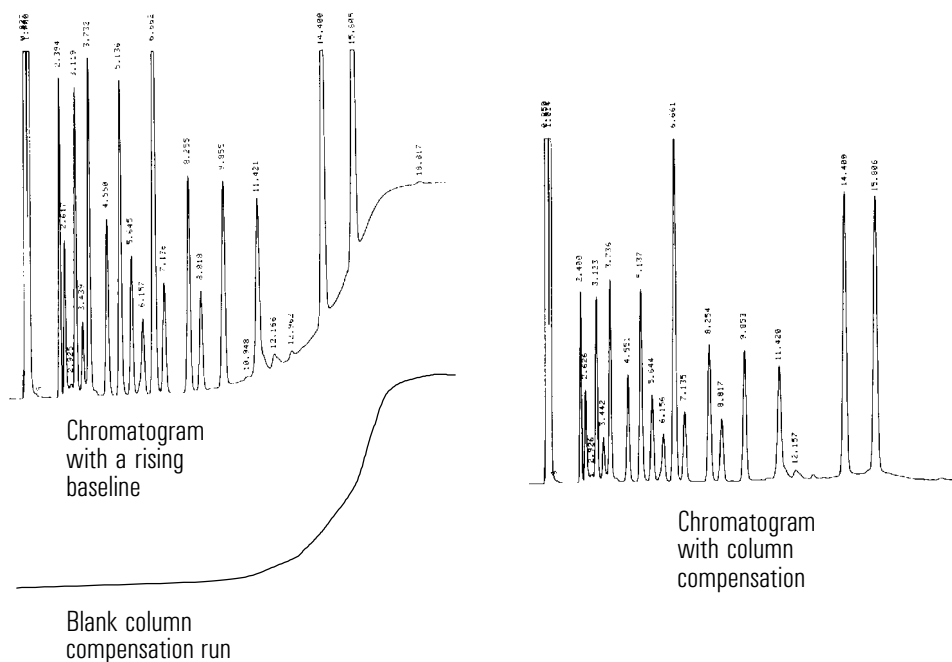

Figure 22. Column compensation

To create a column compensation profile

1. Display this screen.

Status / Setup

Setup		13:03:47	Last Sample 00	Default+	Not Ready
Last Profile		Column Compensation Status		COMP	
Time: --:--:--		Inactive			
Date: -----		Column Compensation Source			
No Data		<input checked="" type="radio"/> detector <input type="radio"/> undefined			
Inlet Setup	Oven Setup	Column Setup	Automation	Configure	

2. Load the method for which the blank run profile is to be created. Press COMP.

The GC will wait until it has equilibrated, make one blank run (no sample injected), and store the data as the column compensation profile.

To apply the column compensation profile

Display this screen. It will vary based on the detector you have.

Status / Settings / Detector / More / Signal / Enter

The screenshot shows a control panel for an FID detector. At the top, it displays 'FID', the time '13:18:40', 'Last Sample 01', 'DEF_GC.M+', and 'Not Ready'. Below this is a menu with radio buttons: 'Detector' (selected), 'Column Comp', 'Detector-Column Comp', 'Test Chromatogram', and 'Other 10'. To the right of the menu are three input fields: 'Zero' set to 'OFF', 'Signal' set to '0.00', and 'PW' set to '0.01 min 20 Hz'. On the far right, there are three buttons: 'ZERO', a button with a checkmark, and 'OK'.

1. Select **Detector - Column Comp** and press **OK**.
2. The output signal is now the detector output minus the stored column compensation profile.

The Flame Photometric Detector (FPD)

Using hydrogen

Warning When using hydrogen (H₂) as a carrier gas or fuel gas, be aware that hydrogen gas can flow into the oven and create an explosion hazard. Therefore, be sure that the supply is off until all connections are made and ensure that the inlet and detector column fittings are either connected to a column or capped at all times when hydrogen gas is supplied to the instrument.

Warning Hydrogen is flammable. Leaks, when confined in an enclosed space, may create a fire or explosion hazard. In any application using hydrogen, leak test all connections, lines, and valves before operating the instrument. Always turn off the hydrogen supply at its source before working on the instrument.

General Information

The sample burns in a hydrogen-rich flame, where some species are reduced and excited. The gas flow moves the excited species to a cooler emission zone above the flame where they decay and emit light. A narrow bandpass filter selects light unique to one species, while a shield prevents intense carbon emission from reaching the photomultiplier tube (PMT).

The light strikes a photosensitive surface in the PMT where a light photon knocks loose an electron. The electron is amplified inside the PMT for an overall gain of up to a million.

The current from the PMT is amplified and digitized by the FPD electronics board. The signal is available either as a digital signal on the communications output or as a voltage signal on the analog output.

The FPD should not be stored at temperatures above 50°C, based on the original manufacturer's specifications for the PMT.

Linearity

Several mechanisms produce sulfur emission. The excited species is diatomic, so that emission intensity is approximately proportional to the square of the sulfur atom concentration.

The excited species in the phosphorus mode is monatomic, leading to a linear relationship between emission intensity and atom concentration.

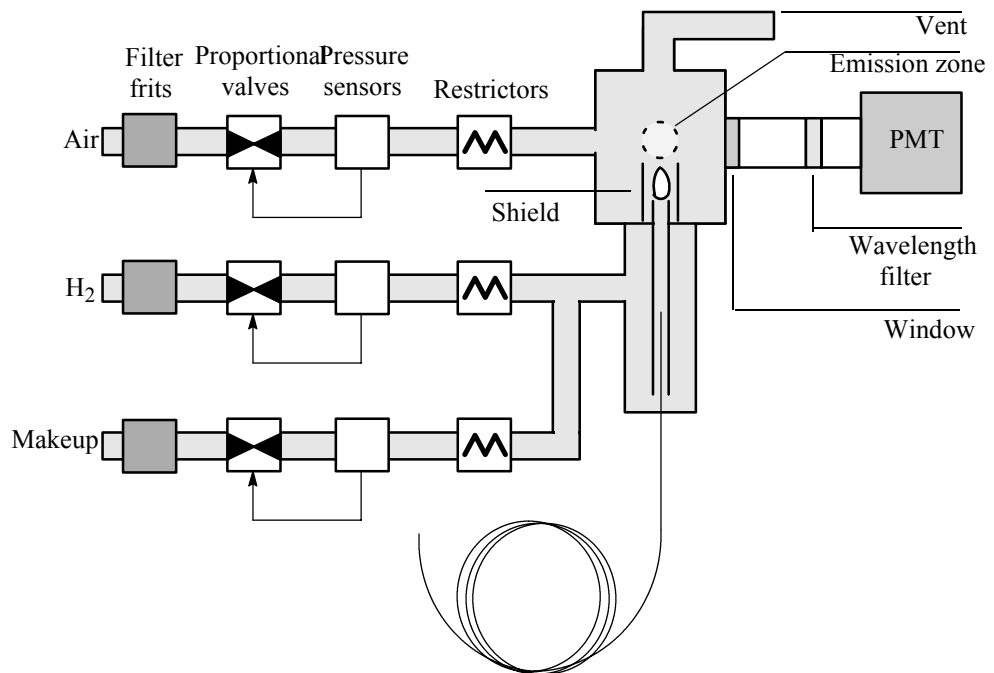

Figure 23. Schematic of a flame photometric detector

Using lit offset

Lit offset is the expected difference between the FPD output with the flame lit and the output with the flame off. It is used to determine whether an attempted ignition has succeeded and to detect a flame-out condition.

If the output with the flame on minus the output with the flame off is greater than Lit offset, the flame is considered lit.

The default setting for `Lit offset` is 2.0 picoamps. This is a good working value for all but very clean gases and systems. You may want to change this setpoint if:

- Your detector is attempting to reignite when the flame is still on, thus producing a shutdown.
- Your detector is not trying to reignite when the flame is out.

Changing the lit offset setpoint

1. Press `More` and select `Lit Offset`.

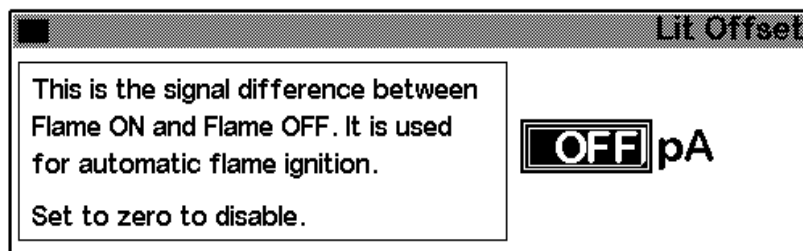

2. Enter a number. The default is 2.0 pA. Enter 0 to disable the automatic reignite function. The setpoint range is 0 to 99.9 pA.
3. Press `OK`.

Igniting the flame

When either of the flame ignition methods on the next page is used, the FPD automatically performs this sequence:

1. Turns all detector gases—air, hydrogen, makeup—off. Carrier remains on.
2. Sets air flow to 200 mL/min.
3. Turns the glow plug ignitor on.
4. Ramps the hydrogen flow from 10 to 70 mL/min.
5. Resets the air flow to the air flow setpoint.
6. Resets the hydrogen flow to the hydrogen flow setpoint.
7. Turns the makeup gas on.

8. Compares the signal change with the `lit_offset` value. If the change is greater than `lit_offset`, declares the flame on (lit). If it is less, declares the flame off (not lit).

For this process to work, there must be enough air pressure to the pneumatics module to provide 200 mL/min flow. We recommend a supply pressure of 90 psi.

Manual ignition

To start the flame ignition sequence, display this screen and press `Flame`.

Status / Settings / Detector

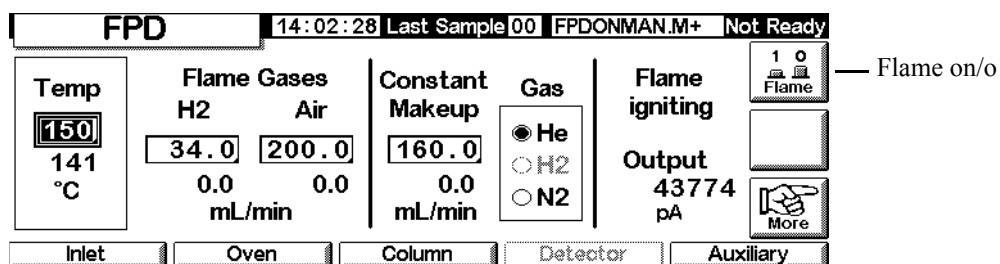

Automatic ignition

If the FPD output with the flame on falls below the flame-off output plus the lit offset value, this is interpreted as a flame-out condition. The FPD runs the flame ignition sequence to relight the flame. If this fails, it runs the sequence again. If the second attempt also fails, the detector shuts down all functions except temperature and makeup gas flow.

Using the electrometer

The Configure Detector contains an electrometer on/off setpoint. It is not necessary to turn the electrometer on or off unless you are performing a maintenance procedure.

Table 23. Electrometer settings

Setting	Description
On	High voltage and signal processing circuits are on. If the photomultiplier tube is exposed to room light with the electrometer on, the tube will be destroyed.
Off	High voltage and signal processing circuits are off. In this condition, it is safe to expose the photomultiplier tube to room light.

Caution Always turn the electrometer off before removing the PMT housing to avoid destroying the tube.

Signal selection

Several types of signals can be selected as the signal output. The selected signal type is available as the SIG connector on the rear panel for processing by an integrator, strip chart recorder, or other external device. The selected signal is also digitally output through the RS-232 connector and optional LAN communications card.

To select the output signal

1. Display this screen.

Status / Settings / Detector / More / Signal / Enter

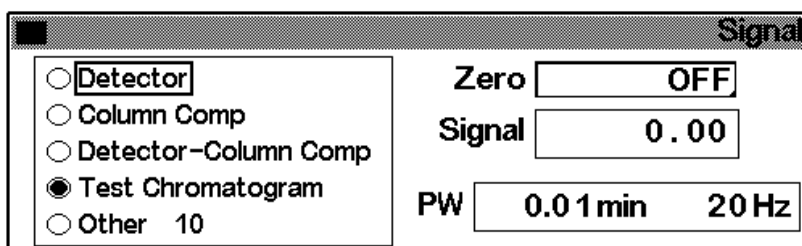

The screenshot shows a menu titled "Signal" with the following options and settings:

- Detector
- Column Comp
- Detector-Column Comp
- Test Chromatogram
- Other 10

Additional settings shown:

- Zero: OFF
- Signal: 0.00
- PW: 0.01 min 20 Hz

2. Select one of the five signal options in the list.
 - *Detector*—the signal produced by the detector.
 - *Column Comp*—the stored column compensation profile (see [Column compensation](#) on page 154).
 - *Detector - Column Comp*—the result of subtracting the column compensation profile from the detector signal.
 - *Test Chromatogram*—stored in the instrument. It provides a reproducible signal to test external signal processing equipment.
 - *Other*—ChemStation or Cerity Chemical sets the signal.
3. Press OK.

To zero the signal

- Enter a value in the `Zero` field. The value is subtracted from all future signal values. Then, press OK.

OR

- Leave the `Zero` field blank, then press the `Zero` key. The GC saves the present value of the signal and subtracts it from all future signal values. Then, press OK.

The Peak Width window

This window displays the digital signal data rate.

Data rates

Analog output for the FPD can be presented at either of two speeds. The faster speed allows minimum peak widths of 0.004 minutes, while the standard speed allows peak widths of 0.01 minutes.

Using fast peaks

If you are using the *fast peaks* feature, your integrator must be fast enough to process the data coming from the GC. It is recommended that your integrator bandwidth be at least 15 Hz.

To use fast peaks:

1. Press More and select Analog output.

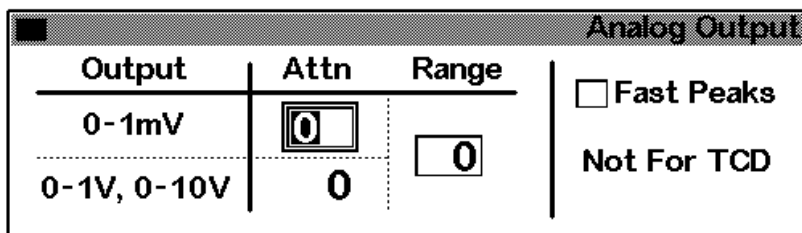

2. Select Fast Peaks.

The fast peaks feature does not apply to digital output.

Selecting the makeup gas mode

The Constant Makeup mode gives a constant flow of makeup gas to the detector.

The Constant Combo mode gives a variable flow of makeup gas to the detector. As column flow changes, the makeup flow adjusts to provide a constant combined flow to the detector.

1. Display this screen.

Status / Settings / Detector / More / Makeup Mode / Enter

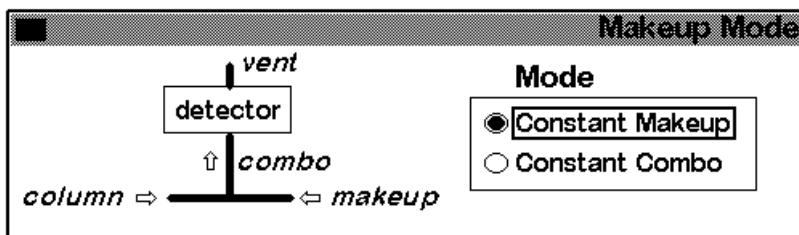

2. Select a makeup mode and press OK.

Using the Detector

Heater configuration

The FPD burner module has a heated zone for the detector body.

FPD Parameters

Table 24 gives the flows for the maximum sensitivity FPD flame, which is hydrogen-rich and oxygen-poor. It is difficult to light the flame with these flows, particularly in the sulfur mode. Helium, used as carrier or makeup gas, may cool the detector gases below the ignition temperature. We recommend using nitrogen rather than helium.

Table 24. Recommended Temperature and Flow

	Sulfur mode flows mL/min	Phosphorus mode flows mL/min
Carrier (hydrogen, helium, nitrogen, argon)		
Packed columns	10 to 60	10 to 60
Capillary columns	1 to 5	1 to 5
Detector gases		
Hydrogen	50	150
Air	60	110
Carrier + makeup	60	60

Supply pressure

Air supply pressure: at least 90 psi for the ignition sequence. All others: adequate to achieve desired flows.

Detector temperature

Below 120°C, flame will not light.

Set temperature about 25°C higher than highest oven temperature—limit is 250°C.

Lit offset

If the detector output (with the flame on) minus the output (with the flame off) falls below this value, the FPD attempts to re-ignite twice. If output does not increase by at least this much, the detector shuts down.

The recommended setting is 2.0 pA. A setting of 0 or Off disables autoignition.

If the flame will not light with the sulfur mode flows shown, change to the phosphorus mode values. After the flame lights, gradually reduce the flows toward the sulfur mode values. Some experimentation will be required to find flows for your particular detector.

Using the FPD

Verify that all detector gases are connected, a column is installed, and the system is free of leaks. Check the oven temperature, inlet temperature, and column flow.

Warning Verify that a column is installed or the FPD column fitting is plugged before turning on the air or hydrogen. An explosion may occur if air and hydrogen are allowed to leak into the oven.

1. Display the following screen.

Status / Settings / Detector

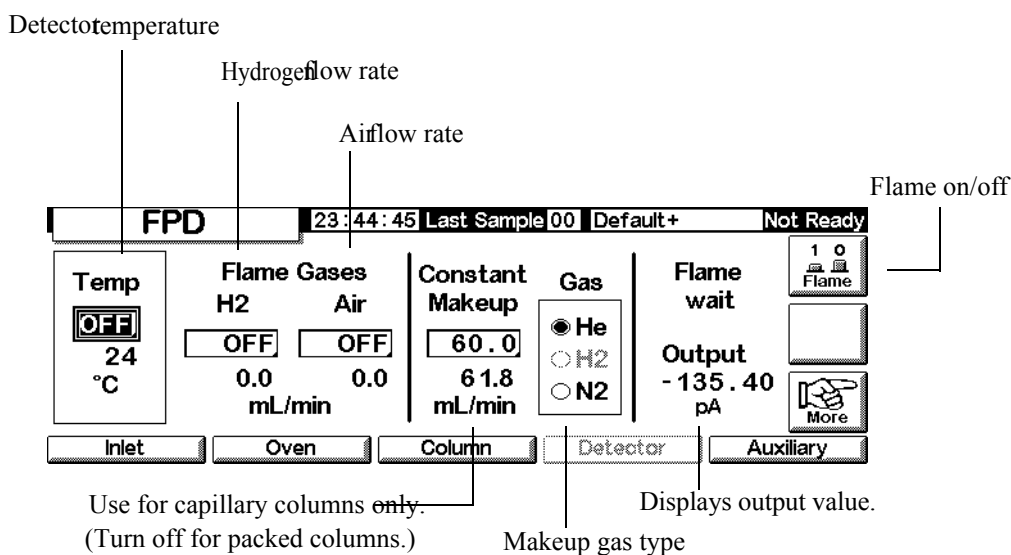

2. Set the detector temperature. The temperature must be greater than 120°C for the flame to light.
3. Enter the hydrogen flow rate.
4. Enter the air flow rate.
5. If you are using *packed columns*, turn off the makeup gas and proceed to step 8.

6. If you are using *capillary columns*:
 - a. If your capillary column is *configured*, select a new flow mode, if desired, and set the makeup gas flow or combined flow. See [Selecting the makeup gas mode](#) on page 163.
 - b. If your capillary column is *not configured*, enter a makeup gas flow. Only constant flow is available.
 - c. Verify that makeup gas type is the same as that plumbed to your instrument. Change the gas type, if necessary.
7. Press **F1**ame. This turns on the air and hydrogen and initiates the ignition sequence. On ignition, the signal increases. Typical levels are 4 to 40 pA in sulfur mode, 10 to 70 pA in phosphorus mode. Verify that the flame is lit by holding a cold, shiny surface, such as a mirror or chrome-plated wrench, over the vent exit. Steady condensation indicates that the flame is lit.
8. Press **OK**.

Valves

The 6850 Series Gas Chromatograph holds either one gas or one liquid sampling valve in a heated valve box on top of the oven. A stream-selection valve (the Multi Valve), mounted outside the GC, can be controlled.

Valves can be controlled:

- Automatically, using a valve sequence (see [To enter the valve parameters](#) on page 56)
- Manually (see [Controlling valves manually](#) on page 171)
- Using Run Table events. Mainly used with switching valves (see [Valve events](#) on page 60)
- Using Clock Table events. To perform analyses when you will not be present (see [Clock Table](#) on page 63)

Valve types

There are four possible valve types:

- *Gas sample valve*—a two-state (load and inject) valve. In the load state, an external gas stream (up to 300 psi) flows through an attached sampling loop and out to waste. In the inject state, the filled sampling loop is inserted into the carrier gas stream. Sample loops are available in various sizes.
- *Liquid sample valves*—similar to the gas sample valve but with different physical construction, they can handle liquefied gases at pressures up to 300 psi and are available in 0.5- μ L and 1- μ L capacities.
- *Switching valves*—used to backflush a column, to select a column, and other uses depending on how it is plumbed.
- *Multiposition valve (Multi Valve)*—provided by the user. A Multi Valve selects one from a number of sample streams and feeds the selected stream to a sample valve. See [Multi Valve with Sample Valve](#) on page 170 for an example of this combination.

Configuring valves

To configure the GC for valves

1. Display this screen:

Status / Setup / Automation

Automation		14:12:13	Last Sample 00	Default+	Not Ready
Injector Turret Size 8 samples 	Valve 1 <input checked="" type="radio"/> Sample <input type="radio"/> Switching <input type="radio"/> none	Valve 2 <input checked="" type="radio"/> Multiposition <input type="radio"/> Switching <input type="radio"/> none			
Injector	Sample Valve	Multi Valve			Auto Prep Run

2. Select the types for Valve 1 and Valve 2.

Sample valves

Plumbing

There are two ways to plumb a sample valve:

- Inserted between an inlet flow module and the inlet. The sample flows through the inlet to the head of the column.
- Inserted between a purged packed inlet flow module and the head of the column (a split/splitless inlet cannot be used). The sample bypasses the inlet.

With this arrangement and an unconfigured column, you can only set flow modes for the column. Total flow setpoint and readings work as expected.

If the column is configured, the GC corrects column flow setpoints and readings for the septum purge flow. With no inlet, that value is zero. The actual column flow is 1 to 2 mL/min *less* than the setpoint in the flow modes. In the pressure modes, the Total flow is the actual column flow.

To configure a sample valve

1. Display this screen.

Status / Setup / Automation / Sample Valve

Sample Valve	14:13:53	Last Sample 00	Default+	Not Ready
Load Time	0.5	min	Sample Loop Volume	5.000
		Inject Time	0.5	min

2. Enter the Load time in minutes.
3. You may enter the Sample Loop Volume. This entry is for reference only; it has no effect on the valve.
4. Enter the Inject time in minutes.
5. Press Esc to save the values and return to the previous screen.

Sample valve cycle

1. The sampling valve changes to the Load state. Load min begins. Valve is not ready.

Load state—The between-runs rest state. The loop is flushed with a stream of the sample, either constantly by plumbing it directly or with a gas or liquid syringe. The column is flushed with carrier gas.

2. Load min ends. The valve becomes ready.
3. If everything else is ready, the GC becomes ready.
4. The user loads the sample loop (if there is no sample stream plumbed to the valve) and presses Start.
5. The sampling valve changes to the Inject state. Inject min begins. The run begins.

Inject state—The activated state. The filled loop is inserted into the carrier gas stream. The sample is flushed onto the column. The run starts automatically. After Inject min ends, the valve changes back to Load.

6. Inject min ends. Return to step 1.

Multi Valve with Sample Valve

If both a Sample Valve and a Multi Valve are configured, the GC assumes that they will be used with the Multi Valve (Valve 2) feeding the Sample Valve (Valve 1).

Several manufacturers provide multiposition valves that can be driven by the 6850 GC. If a valve is configured as a Multi Valve and has a BCD position output connected to the GC, the valve position can be selected directly.

The GC reads the present position of the valve from the BCD input. If the desired position is different, it cycles the driver (close contacts, open contacts) one time and rechecks position. This repeats until the valve reaches the correct position. If the valve does not move, takes too long to move, or does not report that it is in the correct final position, an error will occur.

To configure a Multi Valve

1. Display this screen.

Status / Setup / Automation / Multi Valve

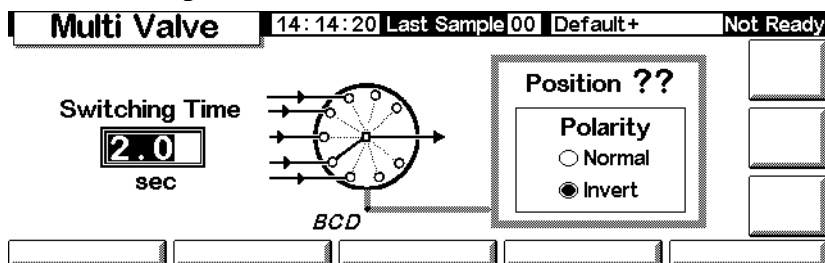

2. Enter a Switching Time in seconds. Viscous samples may require longer times. The default time is 1.0 second.
3. Select Normal or Invert BCD. Invert complements the BCD input—1's become 0's and 0's become 1's. This accommodates coding convention differences among valve manufacturers. The default value is Normal.

Controlling valves manually

When developing a valve-based method, it may be necessary to operate the valves manually.

To move a valve manually

1. Display this screen.

Status / Automation / Valves

Valves		14:14:53	Last Sample 00	Default+	Not Ready
Valve 1	Valve 2	ACTION			
OFF	OFF				
<input type="checkbox"/> Toggle Switching Valve	<input type="checkbox"/> Toggle Switching Valve				
<input type="checkbox"/> Toggle Sampling Valve	Multiposition Valve	RESET			
Load ➡ Inject	Current ?? Next 0				

This GC has a sample valve (Valve 1) and a multiposition valve (Valve 2).

2. Select the valves to be controlled and the directions of the moves. Press ACTION to make the changes. Press RESET to clear the screen without performing any actions.

Sample valves and switching valves toggle between their two possible states. With a multiposition valve, you can enter the desired position (1 to 16) in the Next field. When ACTION is pressed, the valve will advance to that position *if* the BCD sensing is connected—it is not in this example—and the external driving circuitry is correct.

Setting the valve box temperature

The valve box contains a heated block with one valve mounting location. The temperature is controlled by the Auxiliary heater.

1. Display this screen.

Status / Settings / Auxiliary

Auxiliary	14:15:15	Last Sample 00	Default+	Not Ready
Temperature OFF °C 25				
Inlet	Oven	Column	Detector	Auxiliary

2. Enter the desired temperature (range is 10°C to 200°C). Press **ESC** to close the screen.

Normally, the most recent 25 events are listed. You can also view the most recent 50, 100, or 250 events.

To save the entire logbook (up to 1024 entries) to a text file on a PC card, press Save Logbook. (See also [Using PC cards](#) on page 31.)

Diagnostics

To view the diagnostic status

Display this screen.

Status / Service / Diagnostics

Diagnostics	12:11:04	Last Sample 00	Service Mo	Not Ready
GC Serial Number US00000000				<input type="text"/>
Atmospheric Pressure 15.254 psi				<input type="text"/>
GC Start Runs	9			<input type="text"/>
GC Uptime	5 days	7 hrs	6 mins	7 secs
				since last GC memory reset
<input type="text"/>	<input type="text"/>	<input type="text"/>	<input type="text"/>	<input type="text"/>
		<input type="text"/>	<input type="text"/>	<input type="text"/>

The detector test is only available if you are using an FID.

The atmospheric pressure shown is the value measured by the instrument and used in all calculations.

Two Inlet Tests are available: the Leak Test and the Split Vent Test.

Leak Test (All inlets)

The Leak Test pressurizes the inlet and checks the pressure decay over time. The test should be performed after routine inlet maintenance and under normal operating conditions (temperature). If the inlet fails the test, check all fittings for leaks.

The Leak Tests results are entered in the Log Book.

Table 25. Leak Test Parts

Item	Part no.
1/8-inch brass nut	5180-4103
1/8-inch Vespel/graphite blank ferrule	0100-1372
Column nut	5181-8830
Vespel/graphite blank ferrule	5020-8294

To run the Leak test:

1. Display this screen. It may differ depending on the inlet you have.

Status / Service / Diagnostics / Inlet Test

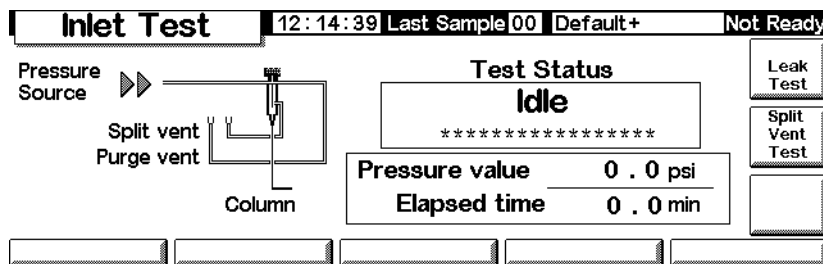

2. Press the Leak Test key.
3. Remove the column, if one is installed. Plug the column fitting with a column nut and a no-hole ferrule (for capillary columns) or with a Vespel® plug (for packed columns). Press OK.

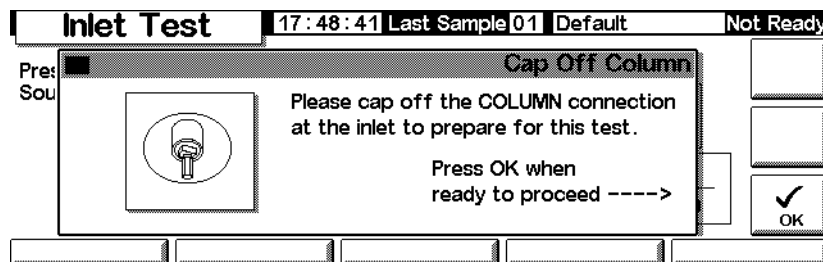

- Cap the septum purge vent with a 1/8-inch Swagelok® cap and press OK.

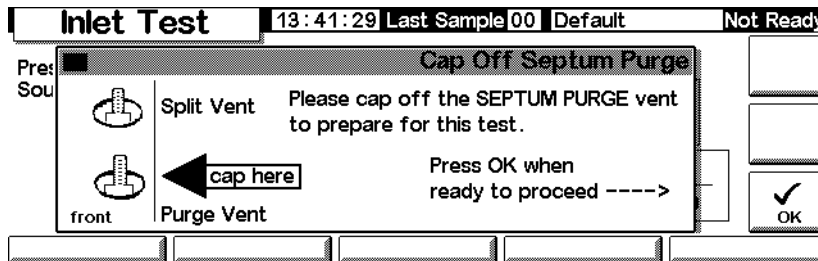

- After you cap the septum purge vent, the Inlet Leak Test screen appears (there may be a slight delay):

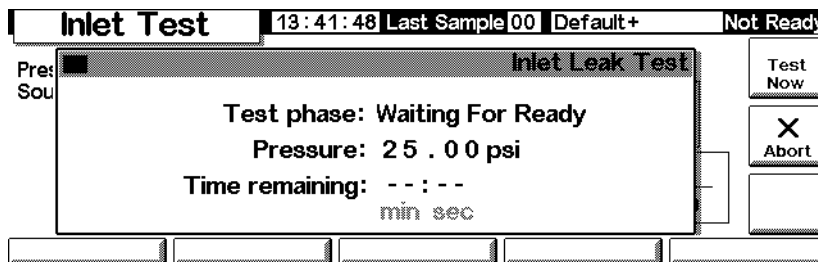

When the GC reaches operating conditions, the test starts automatically. Normally, wait for the test to start. If you want to start the test without waiting for the inlet to reach operating temperature, press **Test Now**.

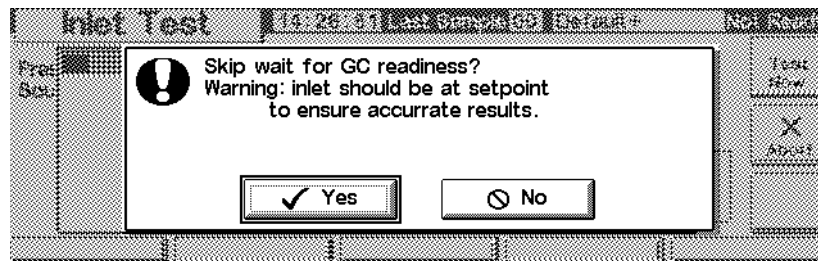

If you select **Yes**, the test begins immediately. It will take approximately 5 minutes to complete.

- When completed, the test result is shown.

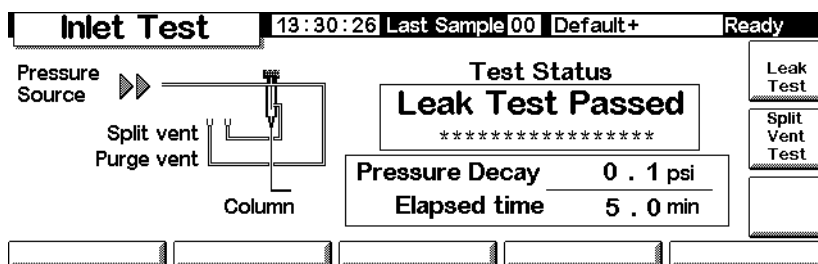

The possible test results are:

- *Passed*—No leaks at operating temperature
 - *Failed*—Check for leaks at all fittings. Refer to the GC user information for more information.
 - *Override*—The inlet passed the test, but the test was started using the **Test Now** key before the inlet reached operating temperatures. The inlet is leak free as tested, but may leak at operating temperatures.
7. Reload the method from beginning of this procedure.
 8. Remove the caps, reinstall the column and configure it as needed, and reset the pressure and low rate.

Split Vent Test (Split/Splitless and PTV inlets only)

The Split Vent Test checks the inlet liner and vent trap for restrictions. Over time, the vent trap and inlet liner can become restricted with sample condensation. If the inlet fails the test, the most likely causes are the vent trap, inlet liner and the gold seal. See your Agilent 6850 User Information manual for further details.

Split vent test results are entered in the Log Book.

Table 26. Split Vent Test Parts

Item	Part no.
Column nut	5181-8830
Vespel/graphite blank ferrule	5020-8294

To run the Split Vent Test

1. Display this screen.

Status / Service / Diagnostics / Inlet Test

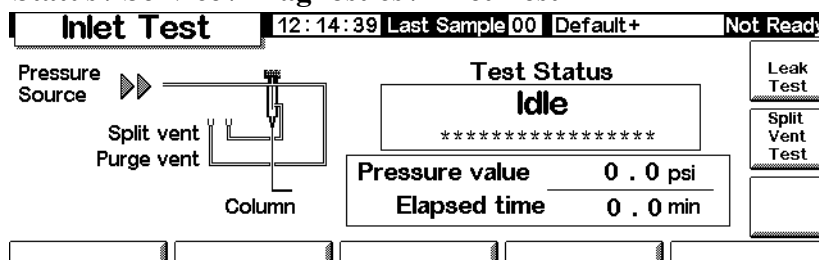

2. Press Split Vent Test.
3. Follow the instructions on the screens.

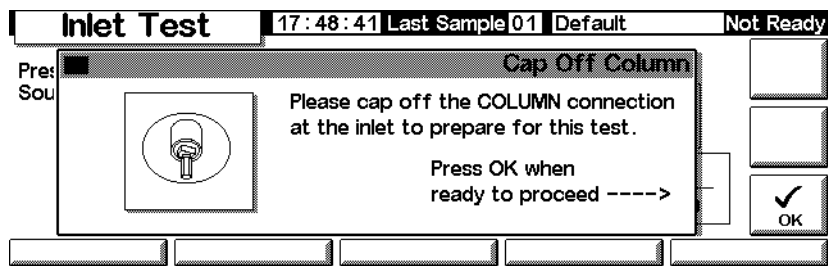

4. After you cap the septum purge vent, the Inlet Leak Test screen appears:

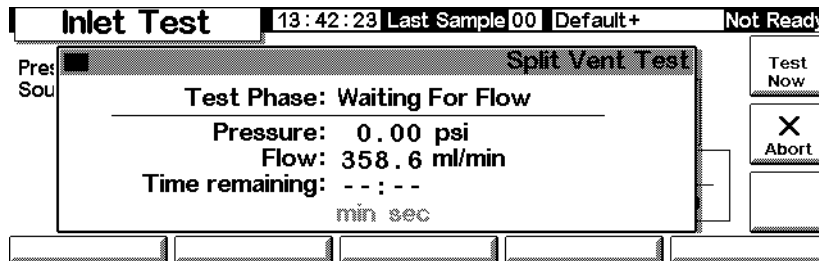

When the GC reaches operating conditions, the test starts automatically. Normally, wait for the test to start. If you want to start the test without waiting for the inlet to reach operating temperature, press **Test Now**.

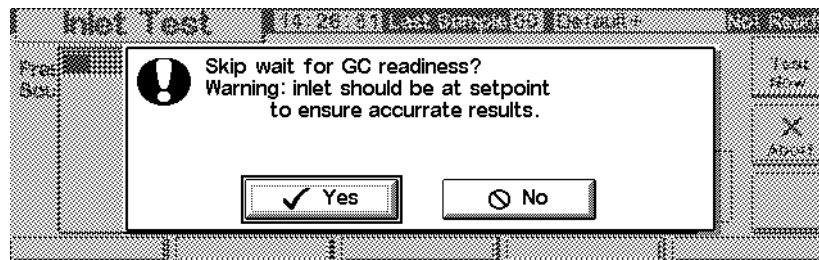

If you select **Yes**, the test begins immediately.

5. When completed, the test result is shown.

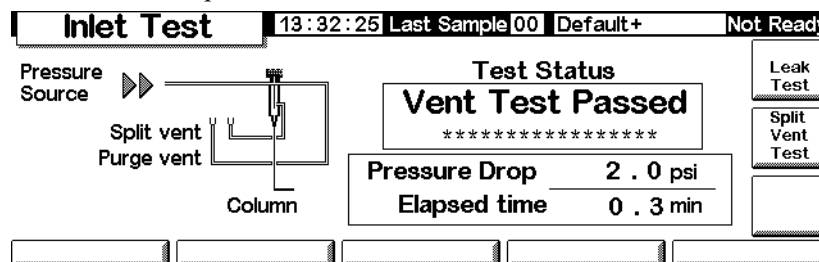

The possible test results are:

- *Passed*—No leaks at operating temperature
- *Failed*—Check for leaks at all fittings. Refer to the 6850 GC user information for more information.
- *Override*—The inlet passed the test, but the test was started using the **Test Now** key before the inlet reached operating temperatures. The inlet is leak free as tested, but may leak at operating temperatures.

Detector (Jet) Test

The FID jet test should be performed when the flame does not ignite or when it unexpectedly re-ignites during a run. The test checks for restrictions in the jet tip. If the jet fails the test, replace or clean it. See your 6850 user information manual for further details.

Jet test results are entered in the Log Book.

To be sure that the test results are valid, perform the test under operating conditions.

Table 27. Jet Test Parts

Item	Part no.
Column nut	5181-8830
Vespel/graphite blank ferule	5020-8294

To run the detector test

1. Display this screen.

Status / Service / Diagnostics / Detector Test

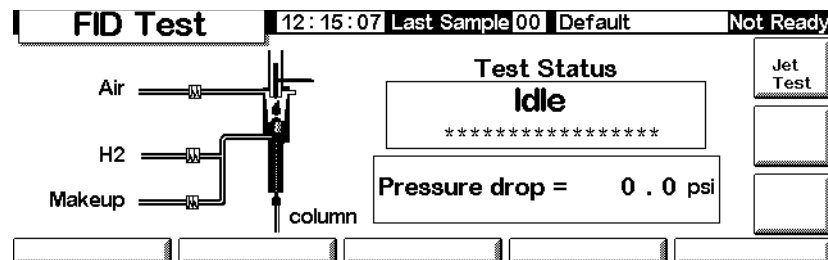

2. Press Jet Test and follow the instructions on the screen.

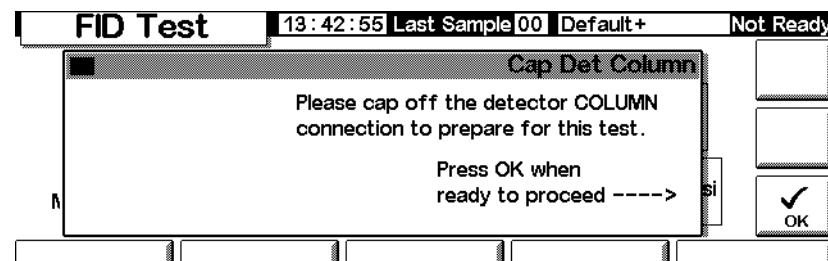

3. After you cap the detector column fitting, the FID Jet Test screen appears:

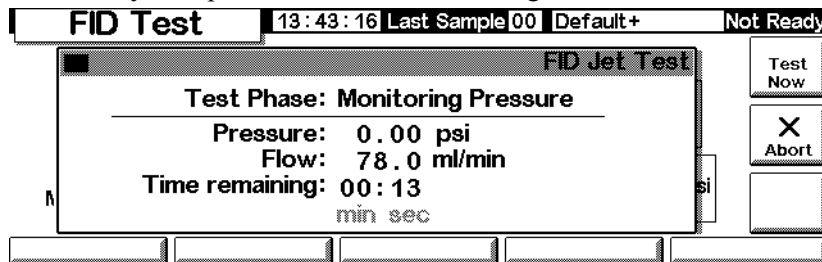

When the GC reaches operating conditions, the test starts automatically. Normally, wait for the test to start. If you want to start the test without waiting for the detector to reach operating conditions, press **Test Now**, then select **Yes** to begin the test immediately.

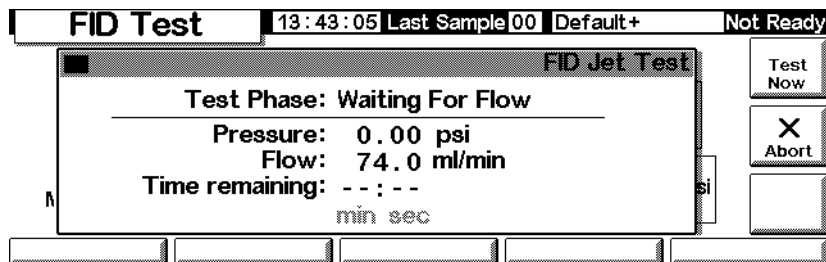

4. When completed, the test result is shown.

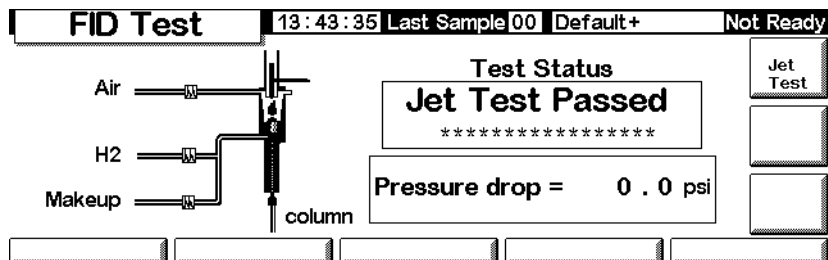

The possible test results are:

- *Passed*—The jet is sufficiently clear or restrictions
- *Failed*—Clean or replace the jet
- *Override*—The jet passed the test, but the test was started using the **Test Now** key before the detector reached operating temperatures. The jet may be acceptable as tested, but may still be restricted at operating temperatures.

Keyboard Test

1. Display this screen.

Status / Service / Keyboard Test

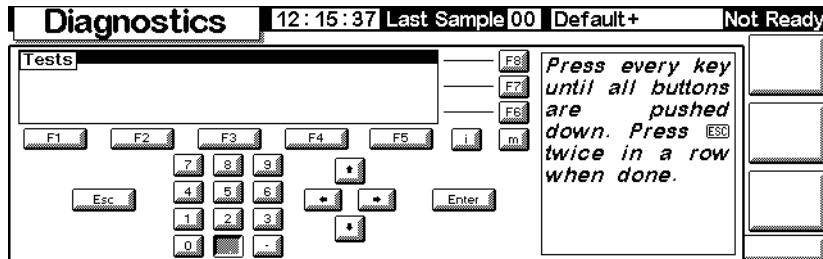

2. Press each key on the Control Module. Its screen image should turn gray.

Calibration

To view the calibration status

Display this screen. The dates of custom calibrations, which overrule the original factory calibrations, are shown.

Status / Service / Calibration

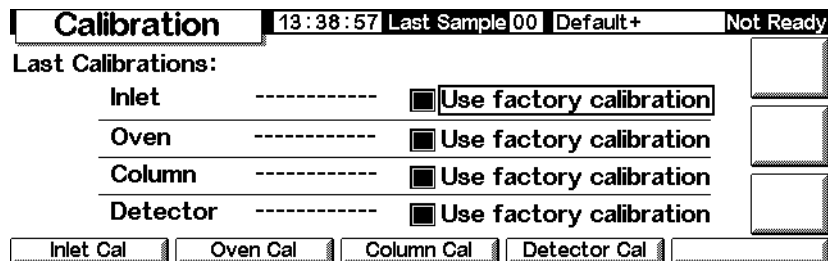

To restore the factory calibration(s)

On the above screen, select the item(s) and press **Enter**.

Flow and pressure sensors

The slopes (sensitivities) of these sensors are quite stable, but the zero offset should be checked periodically.

The split/splitless inlet module uses a flow sensor. Select the **Enable Auto Flow Zero** feature (see [To zero the inlet sensors](#) on page 183) to automatically zero this sensor after each run.

All gas control modules use pressure sensors. These sensors must be zeroed manually. Table 28 gives the recommended zero intervals.

Table 28. Flow and Pressure Sensor Zero Intervals

Sensor type	Column size	Zero interval
Flow	All	Use Enable Auto Flow Zero
Pressure	Small capillary columns (id 320 µm or less)	Every 12 months
	Large capillary columns (id > 320 µm)	At 3 months, at 6 months, then every 12 months
	Packed columns	Every 12 months

To zero the inlet sensors

1. Display this screen.

Status / Service / Calibration / Inlet Cal

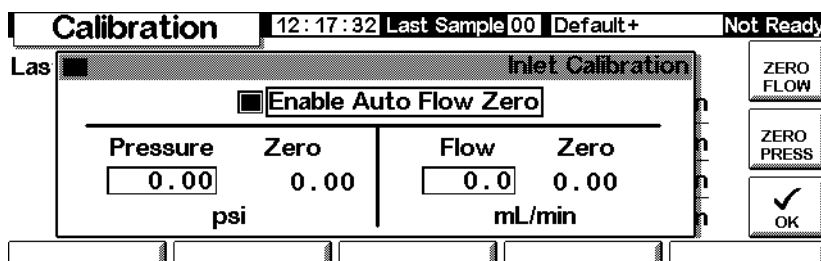

2. Select Enable Auto Flow Zero to automatically recalibrate the zero at the end of every run.
3. To zero the flow sensor manually, press ZERO FLOW. The inlet flow will be momentarily interrupted. The process takes about 2 seconds.
4. To zero the pressure sensor, turn the carrier gas off at the source. Separate one of the connections in the supply tubing to be certain that there is no pressure trapped in the plumbing. Press ZERO PRESS.
5. Restore normal carrier gas flow.

To calibrate the inlet sensors

1. Establish a known pressure (70 to 100 psig or 480 to 690 kPa) or known flow (500 to 1000 mL/min) at the inlet.
2. Enter the known pressure or flow in the appropriate field of the screen.

3. Press **Enter** to recalibrate the sensor.

To recalibrate the oven temperature sensor

1. Attach a thermocouple to the column hanger as shown here. This is the position used at the factory. Be sure that it is suspended in air and not touching anything in the oven.

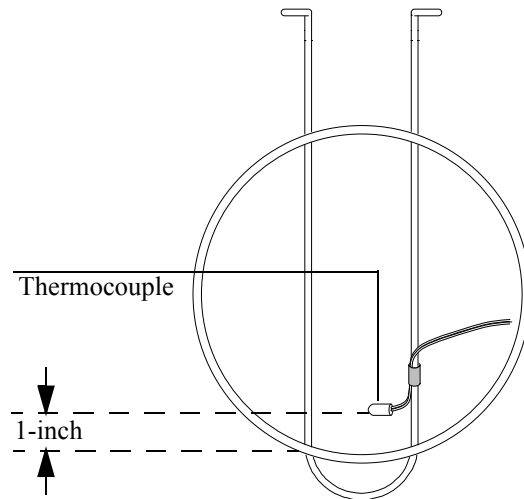
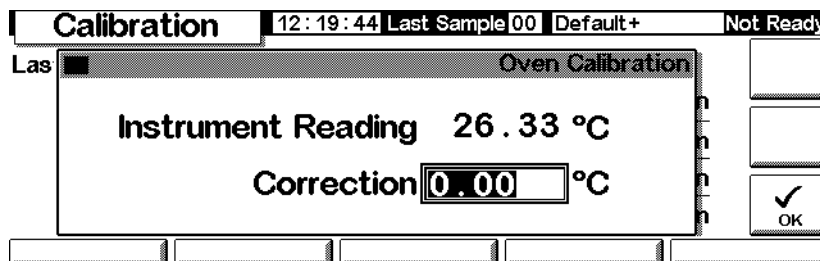

Figure 24. Thermocouple and column hanger

2. Set the oven temperature to a typical value that you use. Let the oven stabilize at that temperature for at least 5 minutes.
3. Subtract the true temperature (the thermocouple measurement) from the instrument reading to obtain the Correction.
4. Display this screen and enter the **Correction** value (–10.00 to +10.00).

Status / Service / Calibration / Oven Cal



5. Press **OK**.

To calibrate a column

If one or more of the column dimensions are unknown and impractical to measure, use this function to estimate the missing information.

1. Display this screen.

Status / Service / Calibration / Column Cal

2. Mount the column in the oven. Establish a flow of carrier gas.
3. On the left side of the screen, select the dimension(s) you need to estimate.
 - To estimate column length *or* diameter, you will need to input *either* the measured column flow rate or the unretained peak elution time
 - To estimate both length *and* diameter, you need to input the measured column flow rate *and* the unretained peak elution time
4. *To determine Measured Flow:* This is the flow exiting the column, and can be measured at the detector exit. (Be sure to turn off detector gases.) An electronic flow sensor is preferred, but you can also use a bubble meter and stopwatch. Make several measurements and average the results. Be sure to convert your measurements to NTP conditions.
5. *To determine Unretained Peak:* This is the time in minutes from injection to appearance at the detector of a peak that does not interact with the column.
6. Enter the data in the appropriate fields, pressing **Enter** after each one. The instrument will calculate and display the column dimensions.
7. Press **OK** to close the screen.

To zero the detector flows

1. Display this screen.

Status / Service / Calibration / Detector Cal

Calibration		13:39:06	Last Sample 00	Default+	Not Ready
FID Gas Calibrations					ZERO FUEL
H2 Fuel		Oxidizer (utility)		Makeup	
Reading	Zero	Reading	Zero	Reading	Zero
0.0	0.0	0.0	0.0	0.0	0.0
mL/min		mL/min		mL/min	

2. With the gases on, press each of the ZERO keys separately. Allow enough time between key presses for the zero operation to occur. Ten seconds minimum is recommended.

Maintenance

The 6850 GC incorporates a feature called Early Maintenance Feedback (EMF), which you can use to track the usage of the inlet septum, inlet liner, the column, and the syringe. By setting a usage limit on these items, you can have the instrument prompt you when it is time to change or service them. For example, the GC can prompt you to change the septum after every 200 injections.

Early maintenance feedback works by tracking the number of automatic injections that have taken place since the last time you changed/serviced each item. It does not count manual injections. You set an upper limit for an item—for example, the septum—and when this limit of injections is reached, a “service warning” message appears on the GC front display. This message does not affect GC readiness; the message is for information only. You can still use the GC normally. Also, each EMF item is activated and set independently.

Using early maintenance feedback

To use early maintenance feedback, display this screen.

Status / Service / Maintenance

Maintenance	14:19:16	Last Sample 00	DEF_M	Ready
Septum	<input type="text" value="0%"/>	 Runs remaining before Early Maintenance Feedback	START SERVICE	
Liner	<input type="text" value="0%"/>		<input type="text"/>	
Syringe	<input type="text" value="0%"/>		<input type="text"/>	
Column	<input type="text" value="0%"/>		<input type="text"/>	
Service Limits	<input type="text"/>	<input type="text"/>	<input type="text"/>	<input type="text"/>

Each of the trackable items is displayed, along with an indicator for percent of useful life remaining. As an example, we will set the septum service limit.

1. Press Service Limits.

Service Limits	14:19:31	Last Sample 00	DEF_M	Ready
# of Injections before service				<input type="text"/>
Septum	<input type="text" value="OFF"/>	Syringe	<input checked="" type="text" value="OFF"/>	<input type="text"/>
Liner	<input type="text" value="OFF"/>	Column	<input type="text" value="OFF"/>	<input type="text"/>
<input type="text"/>	<input type="text"/>	<input type="text"/>	<input type="text"/>	<input type="text"/>

2. Select the Septum field, then use the keyboard to enter a value. In this example, we will use 200 injections.

Service Limits	14:20:09	Last Sample 00	DEF_M	Ready
# of Injections before service				<input type="text"/>
Septum	<input type="text" value="200"/>	Syringe	<input type="text" value="OFF"/>	<input type="text"/>
Liner	<input checked="" type="text" value="OFF"/>	Column	<input type="text" value="OFF"/>	<input type="text"/>
<input type="text"/>	<input type="text"/>	<input type="text"/>	<input type="text"/>	<input type="text"/>

- Return to the previous screen. Note that the status bar for the septum shows 100%, and the number of injections remaining is 200.

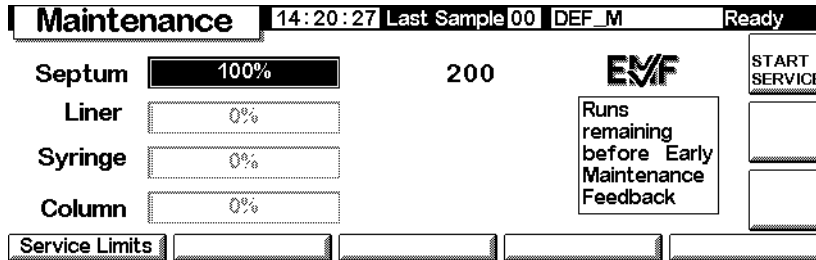

The GC will now track septum usage.

Resetting the service limits

When the service limit for an item expires, a warning message appears on the GC display and on the Control Module. To clear the message, you must either turn off EMF for that item, or reset the counter.

Reset the counters as described below.

- Wait until you are not in a run or sequence and are ready to replace/service the item(s), then display the following screen.

Status / Service / Maintenance / Start Service

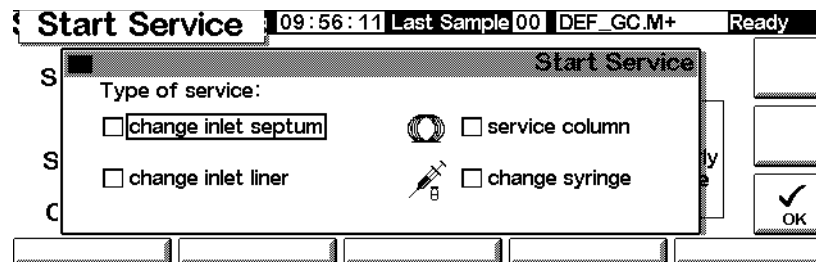

- Select the item(s) that you will service, and press OK.

3. The following screen appears. Select **Yes** or **No**.

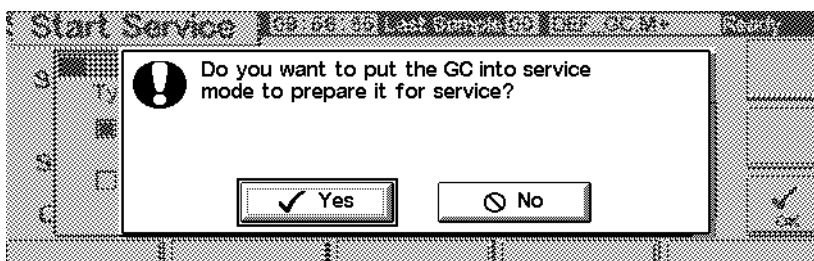

- *Yes*—The GC will load the SERVICE method for you, so the inlet and oven are cooled to safe handling temperatures (See your *6850 GC Information* CD-ROM for details about the settings in a good SERVICE method.)
 - *No*—Does not load the SERVICE method. You do not normally need to cool the GC to service the syringe, for example. If handling hot parts, be sure to protect yourself from burns.
4. The following screen appears. When you have serviced the item(s), press **Yes** to reset the counters you selected above. If you press **No** (for example, if you did not make any changes), the counters will not be reset and the service warning message(s) will remain.

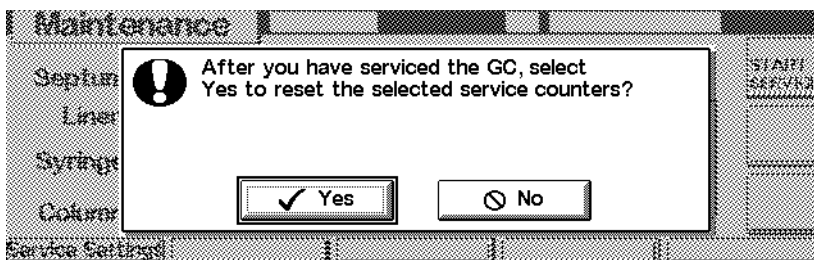

Determining service limits

The service limits to use for the septum, syringe, inlet liner, and column depend on your usage. Pick limits that prompt you to change or service the parts before you expect to see degradation in performance due to a leaky septum or syringe, contamination due to septum coring, etc.

Update functions

To see the current GC, injector and Control Module model number, serial number, and firmware information, display this screen:

Status / Service / Update

Update				14:17:45	Last Sample 00	DEF_M	Not Ready
	GC	Control Mod	Injector				
Model Number	6850	G2629A	G2880				
Serial Number	US00000628	DE85100001	PP00000104				
Mfg Date	30 Jul 99	-----	-----				
FW Revision	A.03.00	A.03.00	A.09.21				
FW Build Date	25 May 00	13 Jun 00	-----				
GC Update		Injector Update	Mod Update				

We recommend that you copy this information to some other location so that it is available if you call Agilent service.

Contact Agilent service for firmware upgrades. To update any firmware, you need a Control Module and a PC card containing the update files.

Do not update firmware during a run.

GC Update

When you update GC firmware, all stored methods and local LAN addressing information is lost. Before beginning the update:

- Record all your GC methods for re-input, or store them on a PC card using the Control Module. (See [To copy a method from the GC to a PC card](#) on page 32.)
- If using local LAN addressing control (see [IP address settings](#) on page 18), go to Status / Service / LAN Comm and record the LAN information for re-entry.

To update the GC firmware:

1. Disconnect the Control Module from the GC.
2. Insert the PC Card with the GC firmware in the Control Module and connect the module to the GC.
3. Display this screen.

Status / Service / Update / GC Update

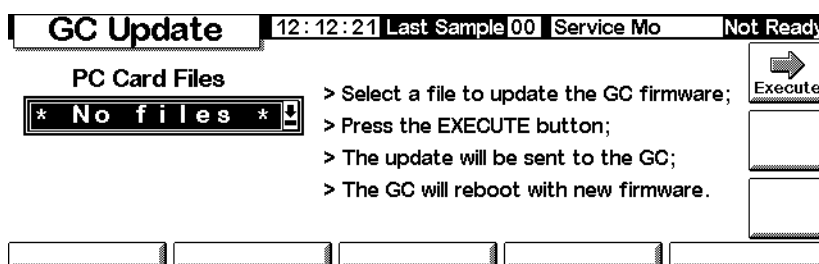

4. Select the GC update file (.asc extension) and press Execute.

Caution

Do not turn off GC power, disconnect the GC power cord, or disconnect the Control Module from the GC until the update process is either completed or cancelled. A disruption to the Control Module during the firmware update can make the GC unusable!

5. When the confirmation screen appears, reply:
 - Yes to load the new GC firmware. The process takes about 10 minutes.
 - No to cancel the firmware load. The existing firmware remains.
6. When loading is complete, the GC will restart using the new firmware.
7. Restore your methods and local LAN addressing information (if used).

To update the injector firmware

Control Module firmware version A.03.00 or greater is required to update the injector. If not available, contact Agilent.

1. Disconnect the Control Module from the GC.
2. Insert the PC Card with the Control Module firmware in the Control Module and connect the module to the GC.

3. Display this screen.

Status / Service / Update / Injector Update

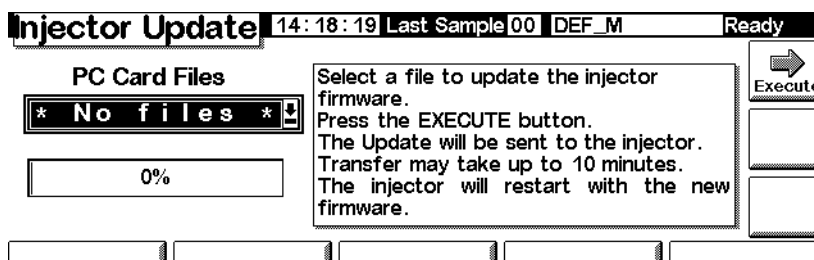

4. Select the Injector update file and press Execute.

Caution

Do not turn off GC power, disconnect the injector power cord from the GC, or disconnect the Control Module from the GC until the update process is either completed or cancelled. A disruption to the Control Module during the firmware update can make the injector unusable!

5. When the confirmation screen appears, reply:
 - Yes to load the new injector firmware. The process takes about 2 minutes.
 - No to cancel the firmware load. The existing firmware remains.
6. When loading is complete, the injector will restart using the new firmware.

To update the Control Module firmware

1. Disconnect the Control Module from the GC.
2. Insert the PC Card with the Control Module firmware in the Control Module and connect the module to the GC.
3. Display this screen.

Status / Service / Update / Mod Update

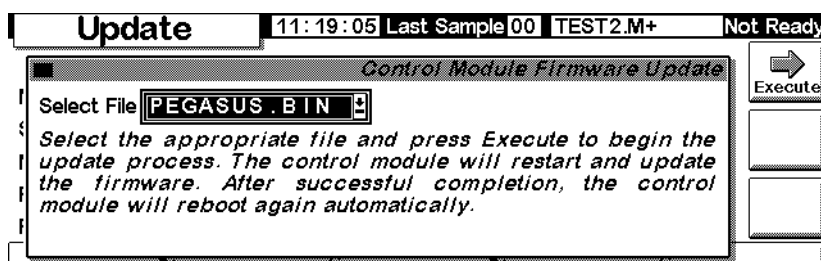

4. Select the Control Module update file and press **Execute**.

Caution

Do not disconnect the Control Module from the GC or turn off the GC until the update process is either completed or cancelled. Doing so can destroy the programs in the Control Module and make the Control Module unusable.

5. When the confirmation screen appears, reply:
 - **Yes** to load the new Control Module firmware. The process takes about 2 minutes.
 - **No** to cancel the firmware load. The existing firmware remains.
6. When loading is complete, the Control Module will restart using the new firmware.